

Plato-C

OWNER'S MANUAL /

Instructions for Assembly

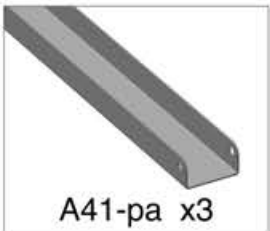

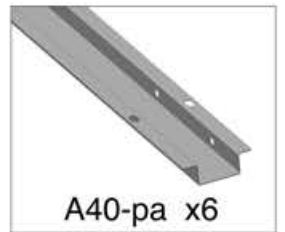
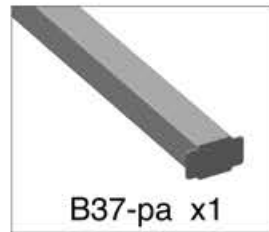
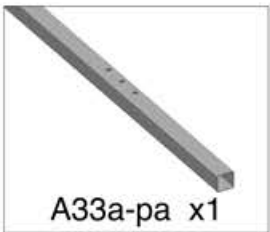
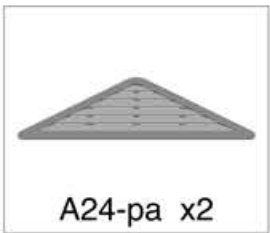
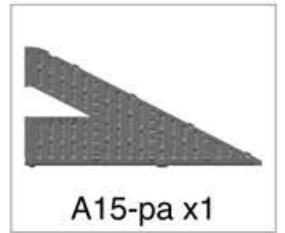
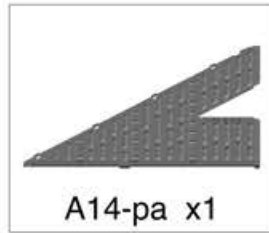
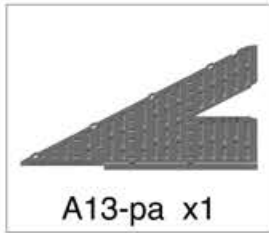
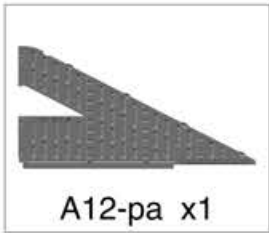
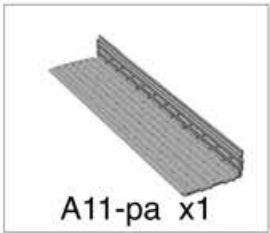
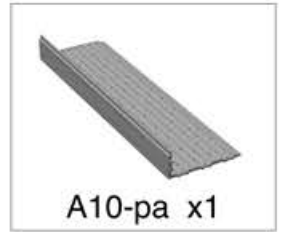
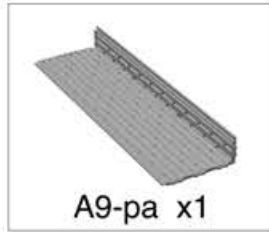
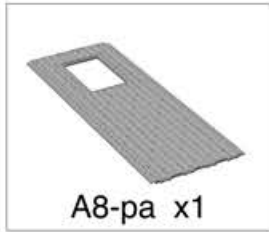
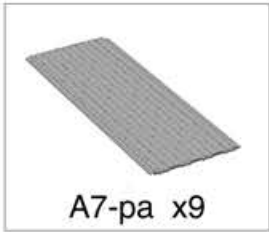
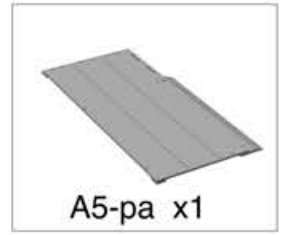
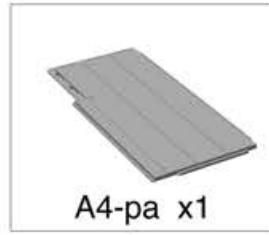
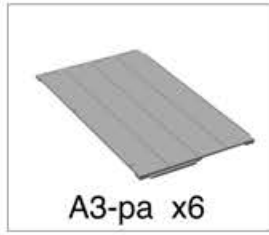
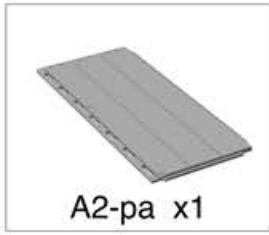
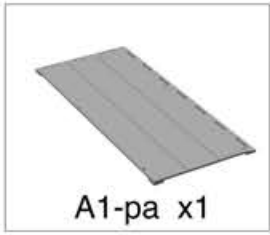

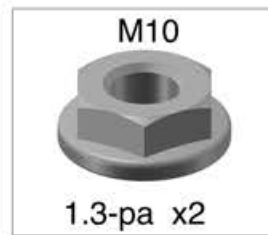
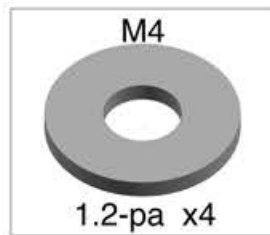
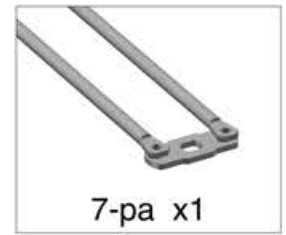
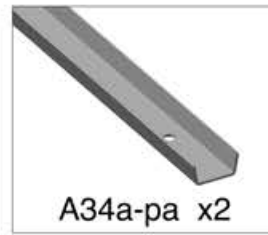
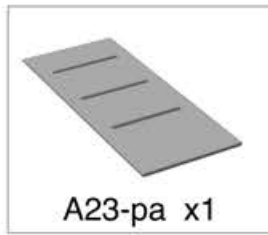
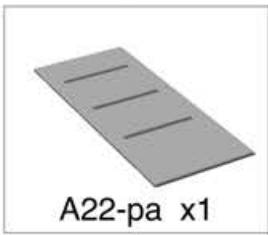
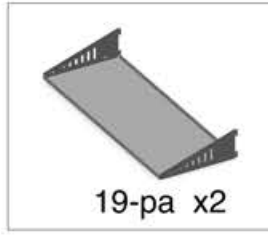
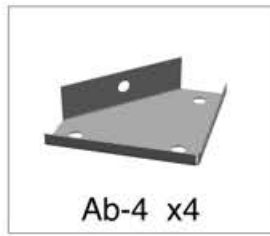

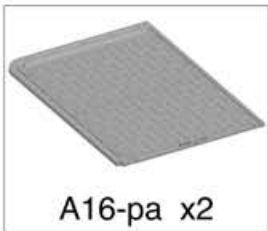

A16-pa x2



A17-pa x2

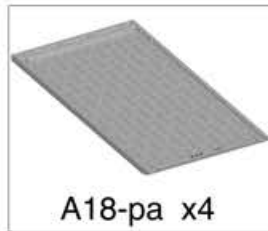

A18-pa x4



A44-pa x4



A45-pa x4



A19-pa x1



A20-pa x1



A21-pa x2



M4x10mm

C50-pa x18



ST4x12mm

C51-pa x56



ST4.2x13mm

C52-pa x4



M6x10mm

C53-pa x74



M6x18mm

C54-pa x45



M4x25mm

C55-pa x13



M6x40mm

C56-pa x5



ST6x12mm

C57-pa x20



ST6x16mm

C58-pa x125



ST6x20mm

C59-pa x64



ST8x60mm

C60-pa x15



M6

C61-pa x38

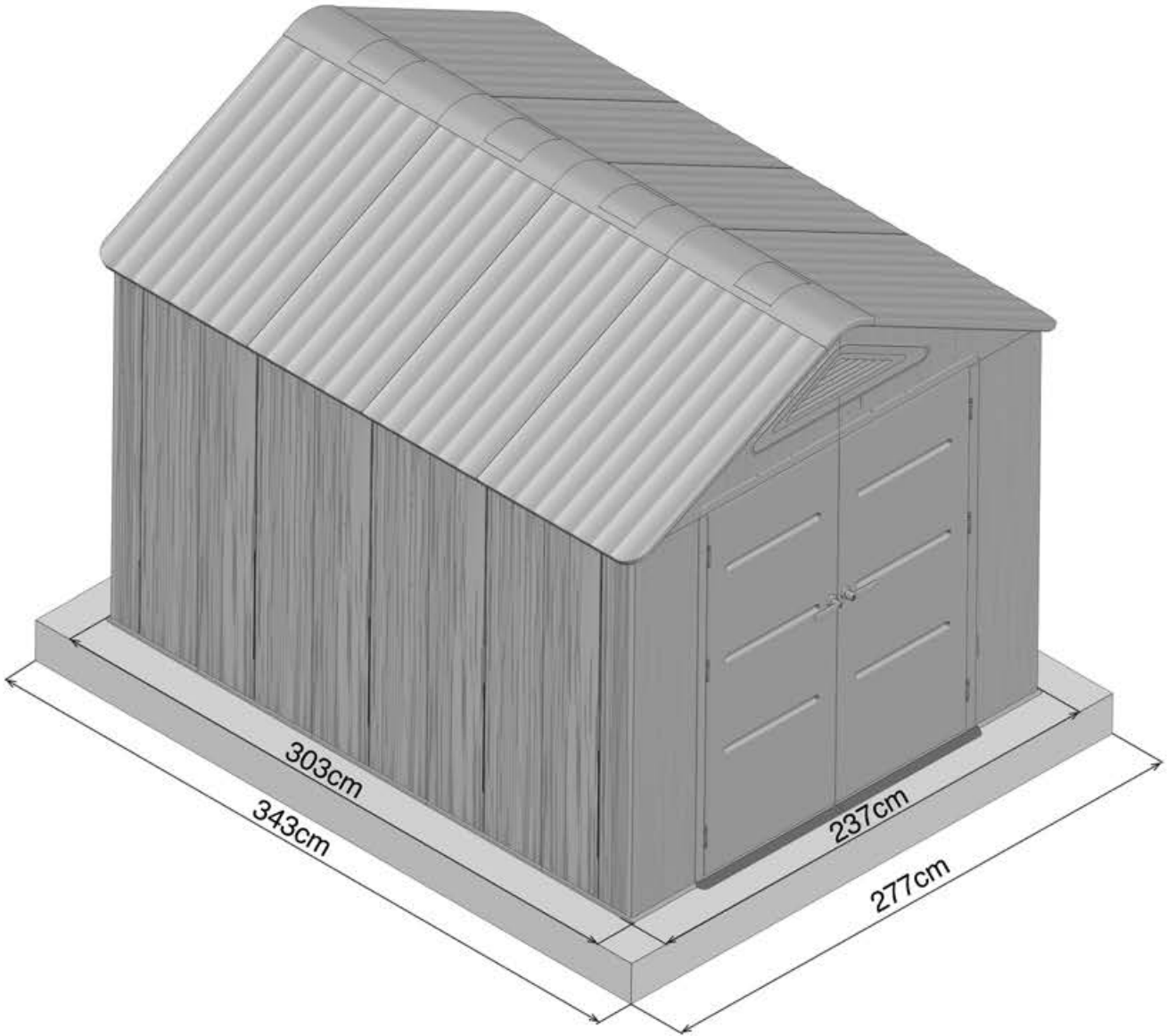

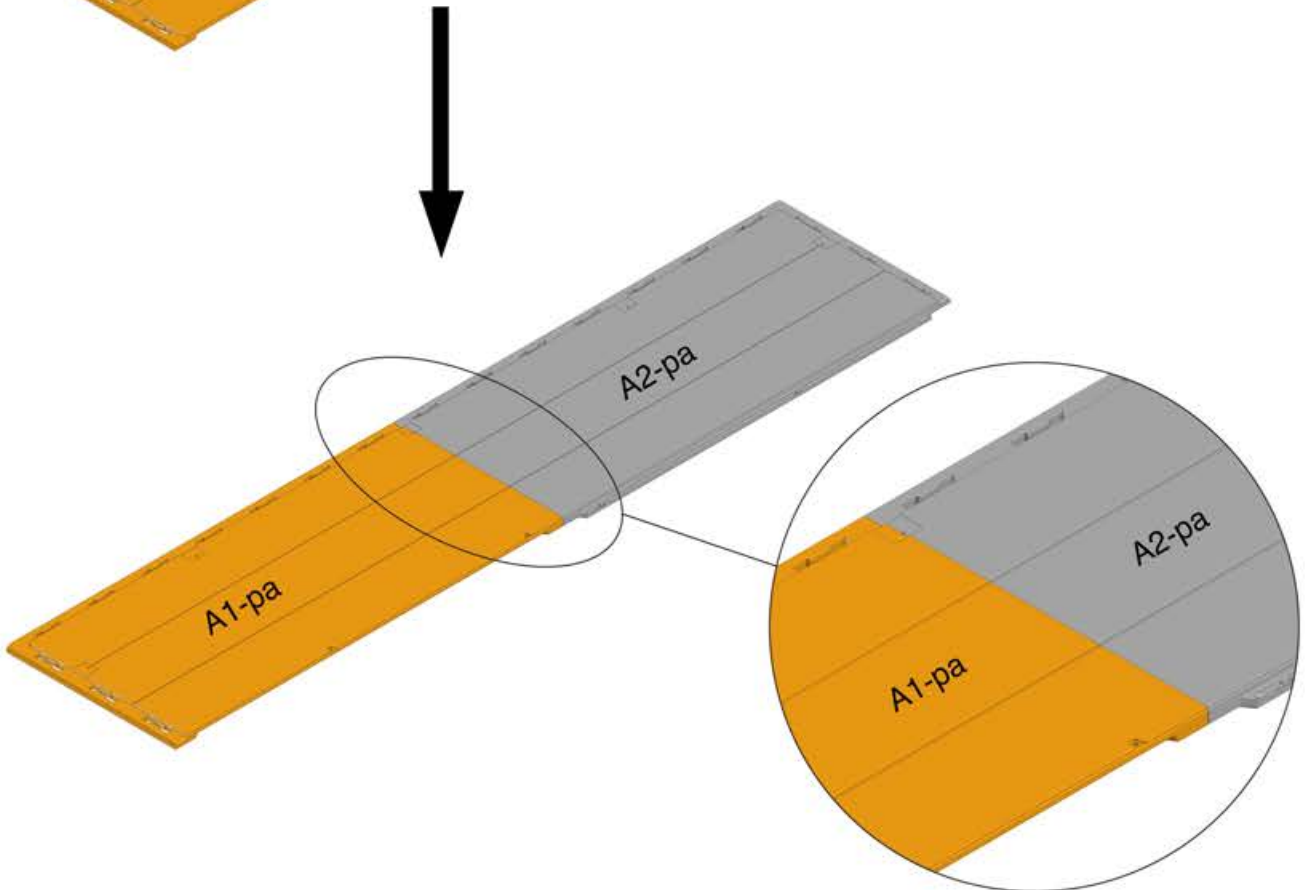
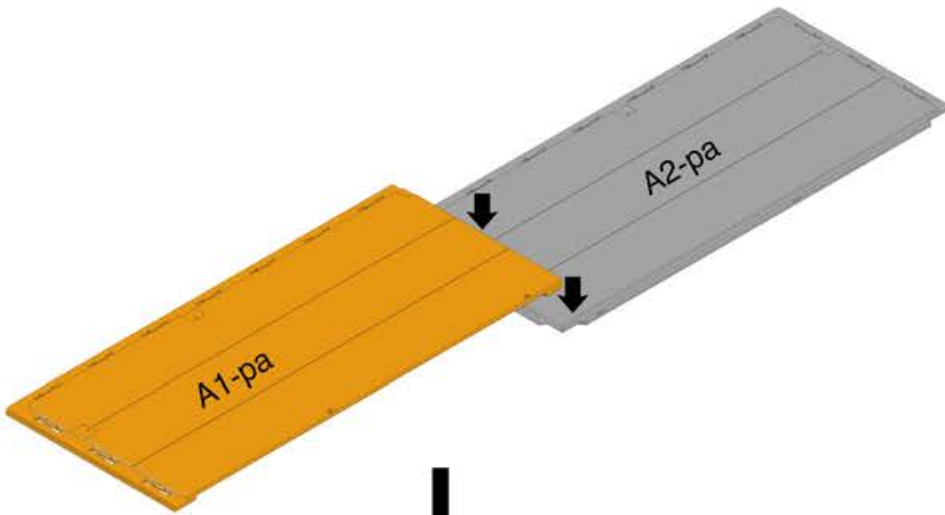
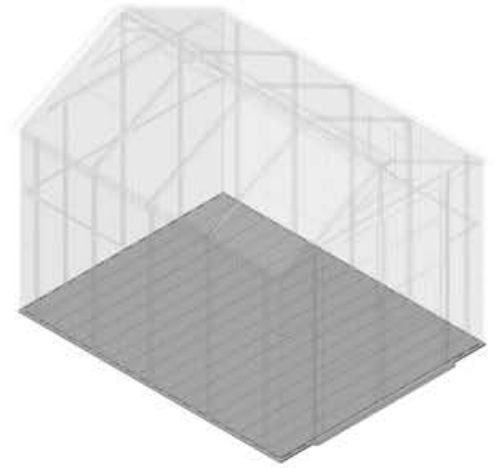
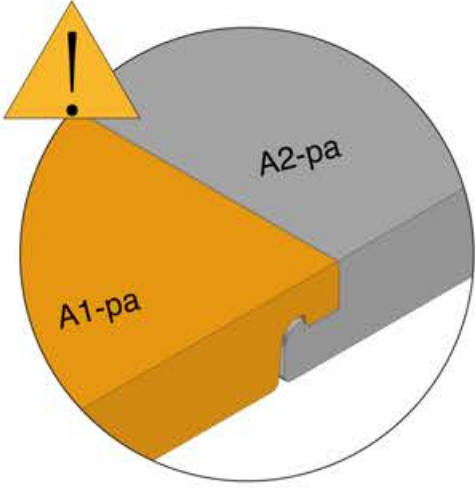
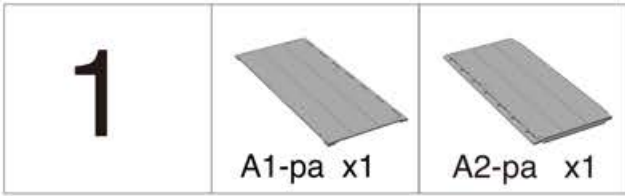

2



A3-pa x2

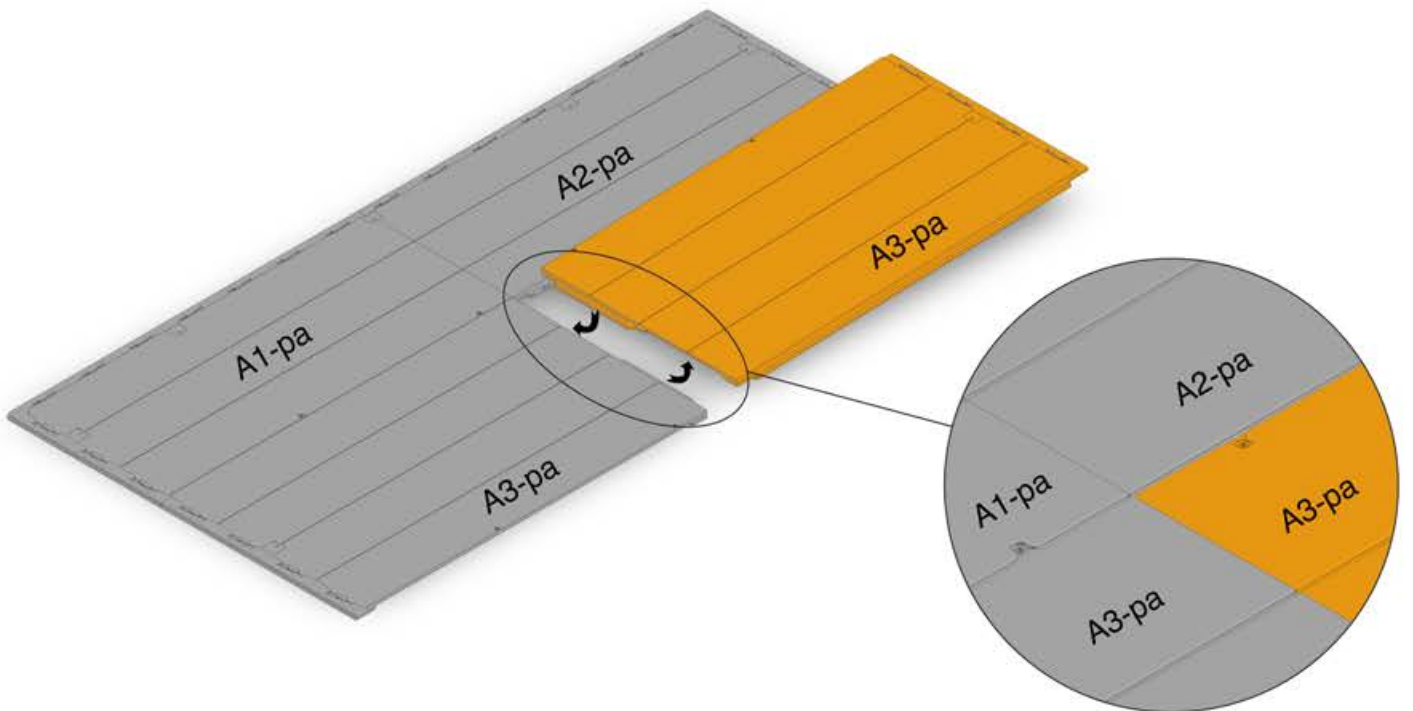
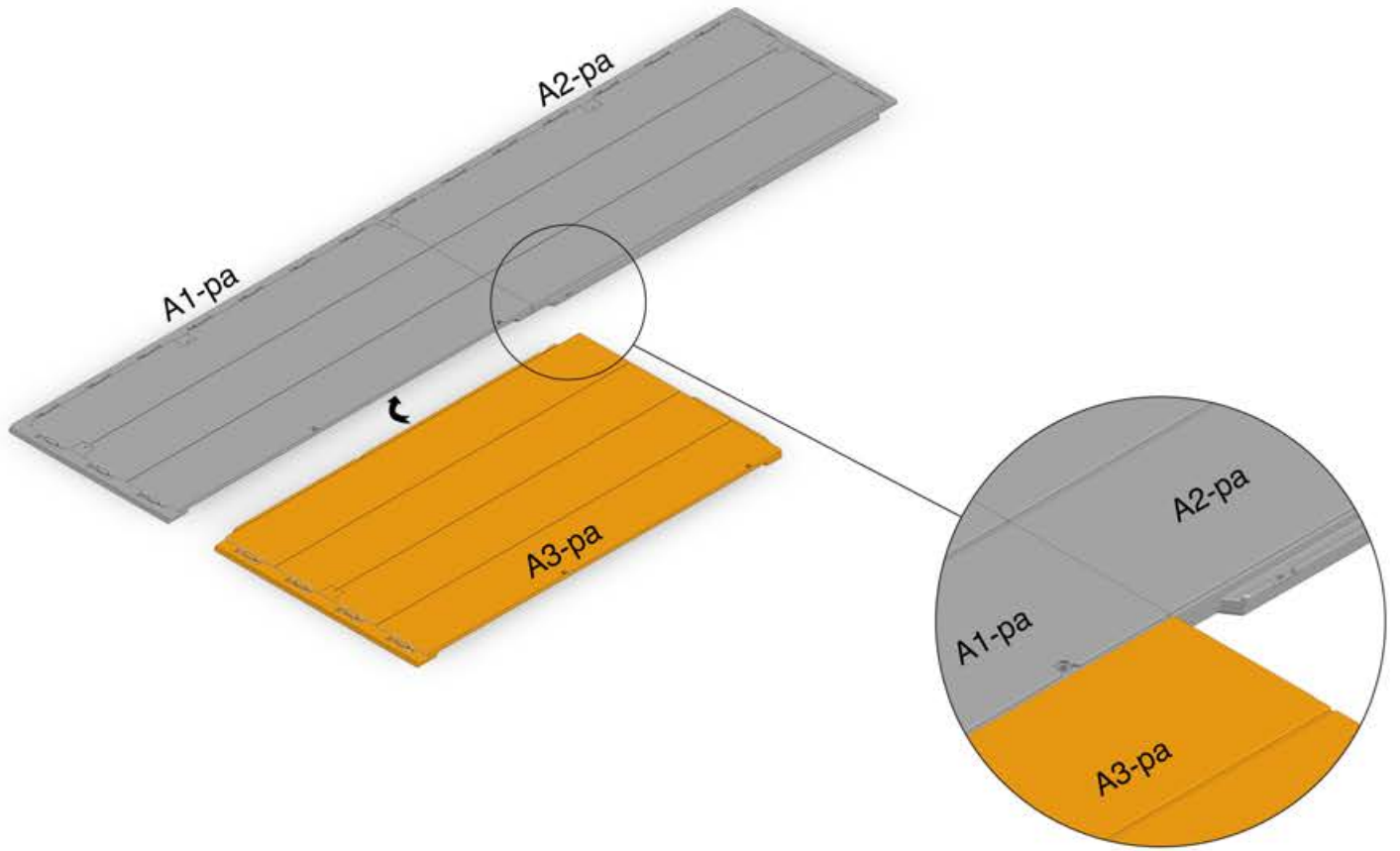

3



A3-pa x4

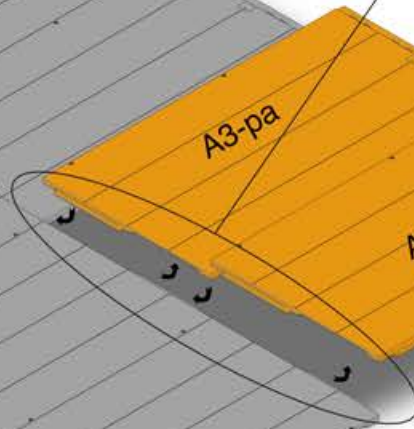
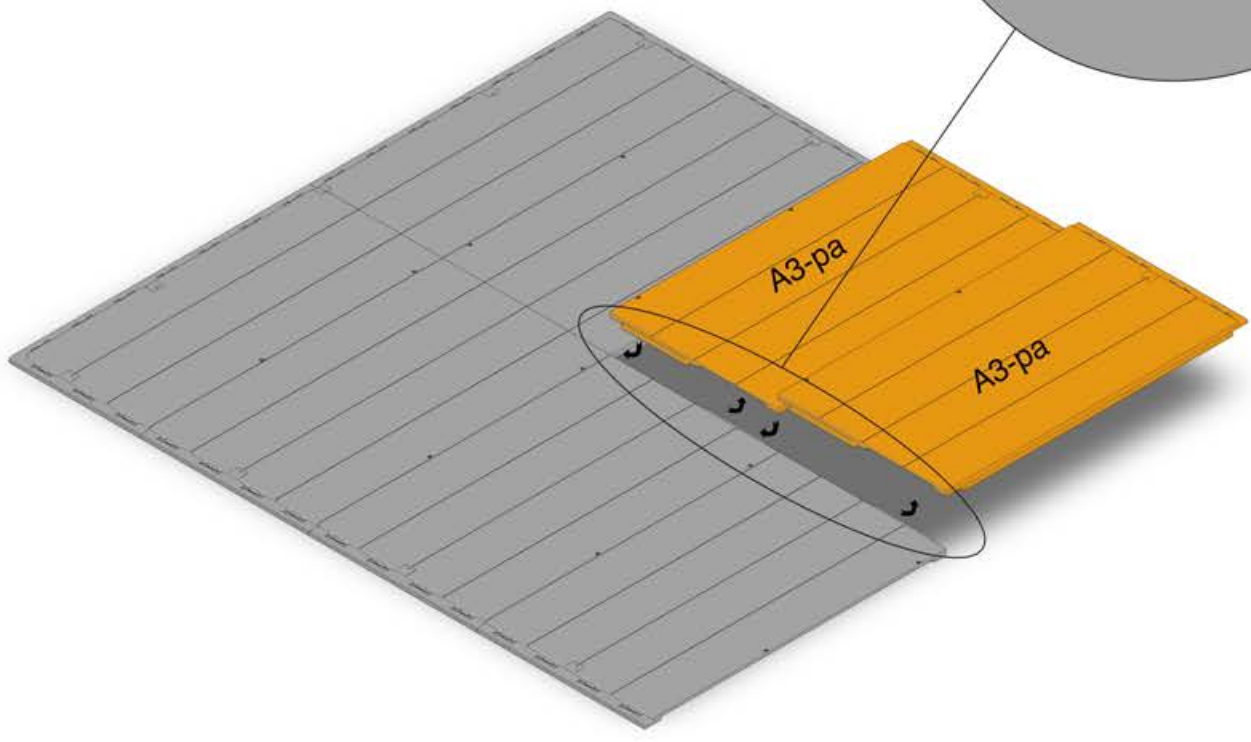
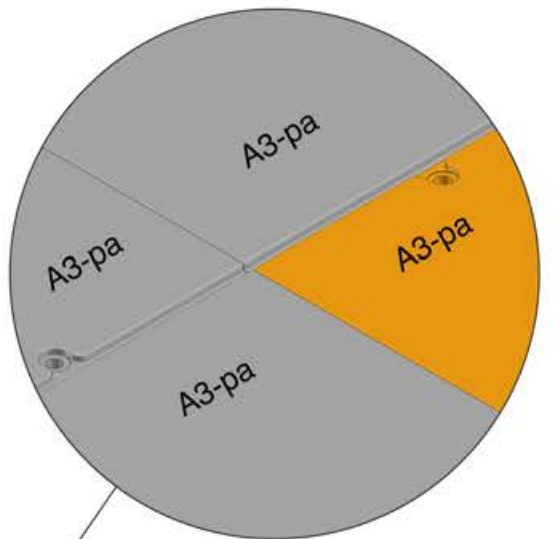
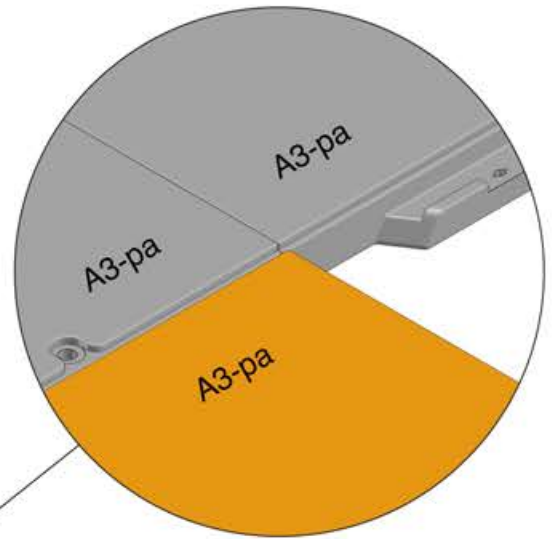
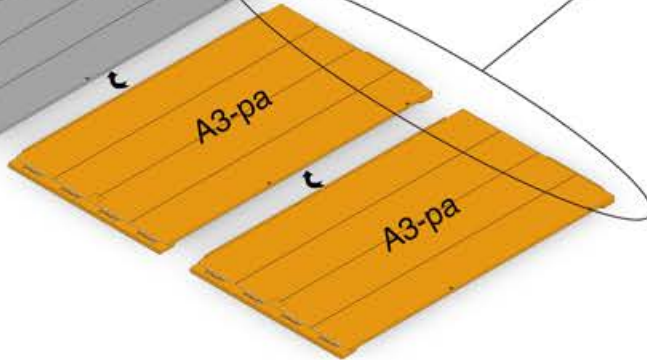
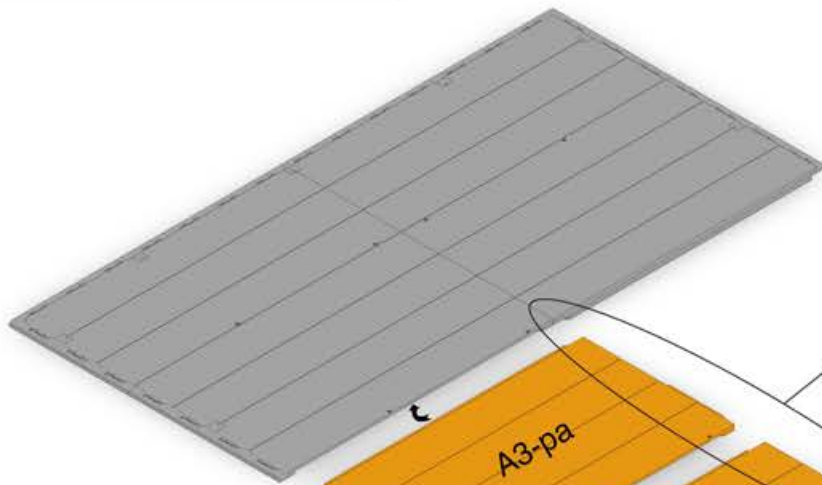

4



A4-pa x1



A5-pa x1



C58-pa x17

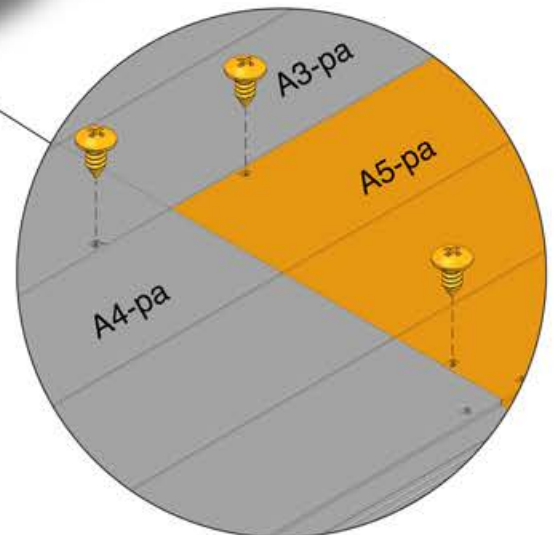
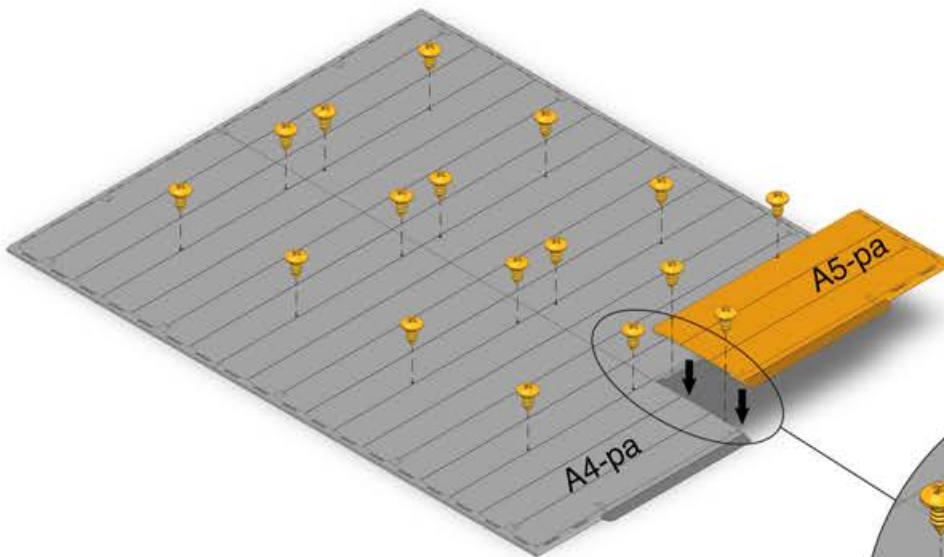
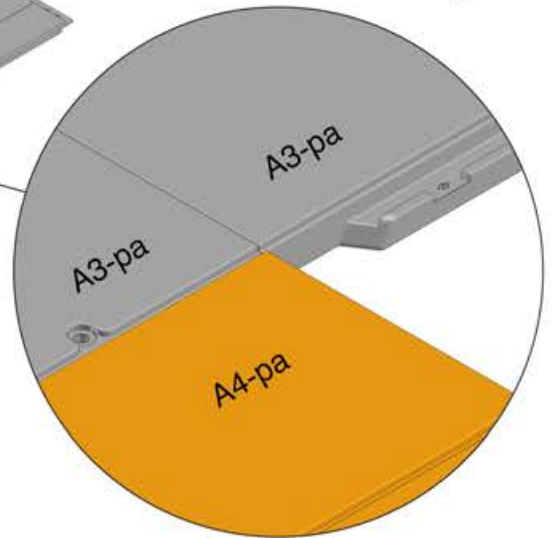
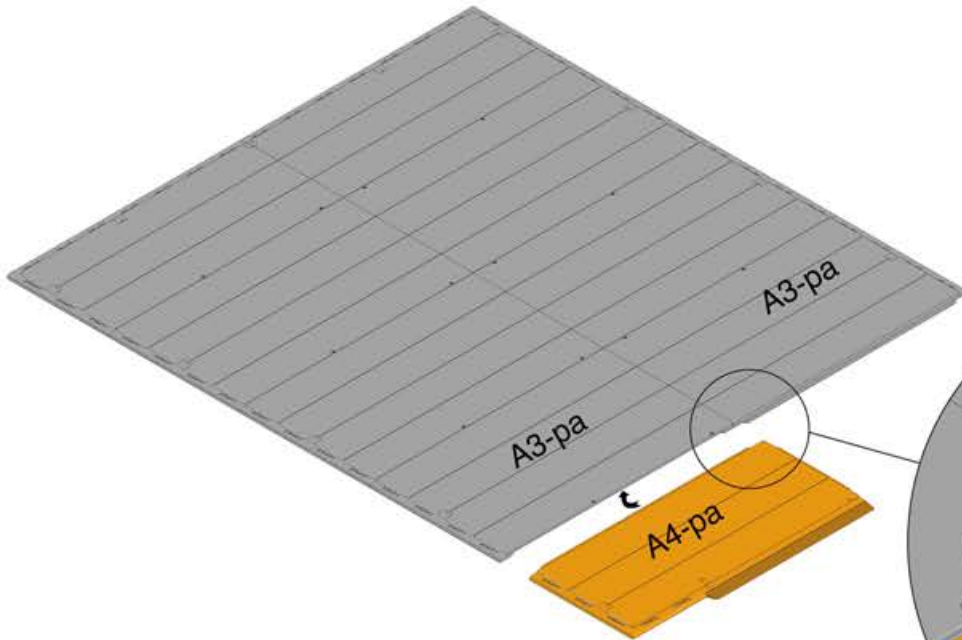

5



A6-pa x1

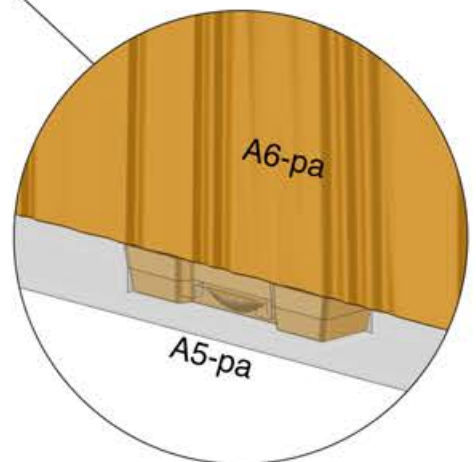
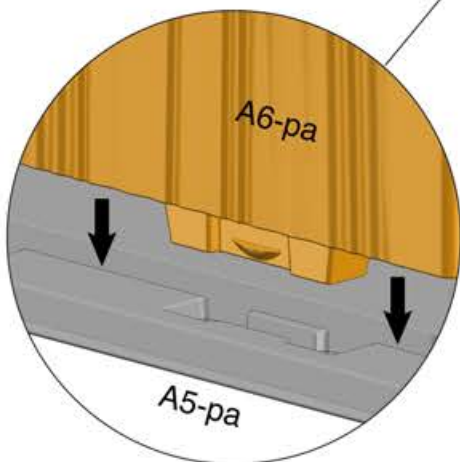
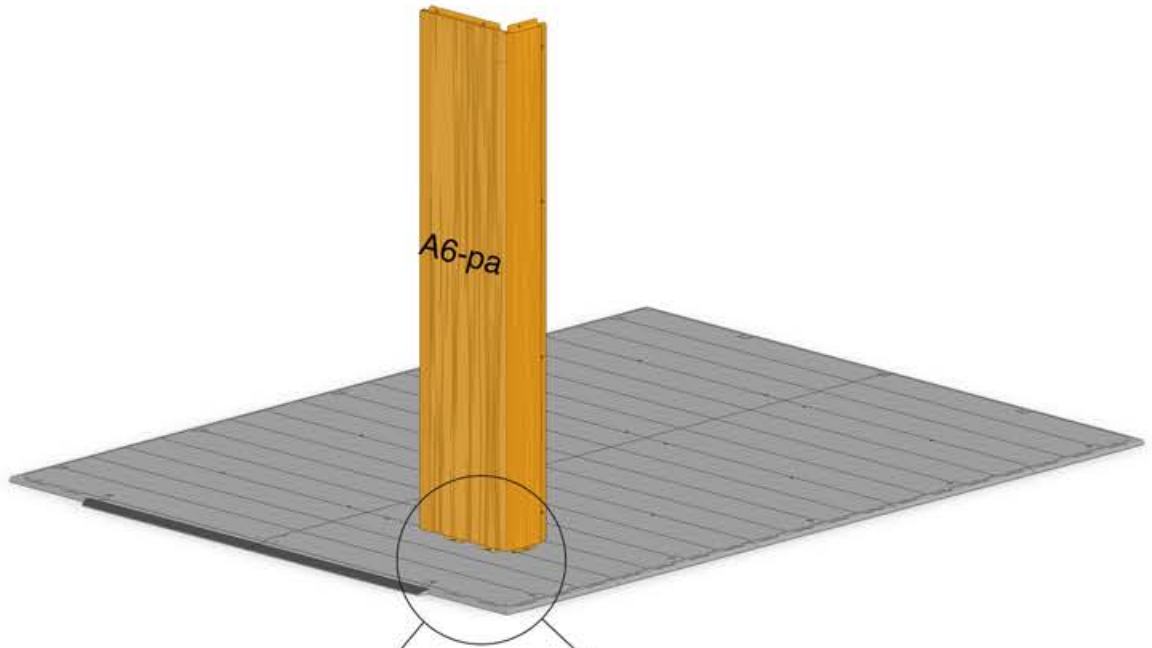
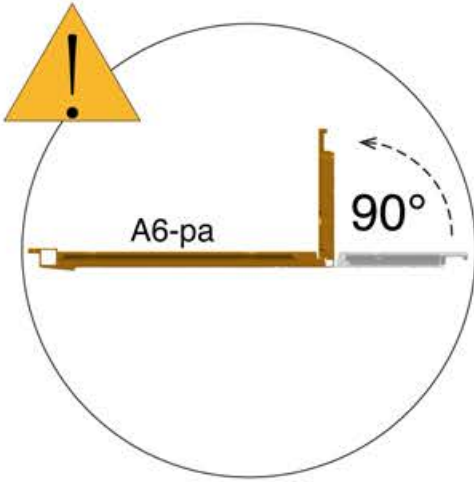
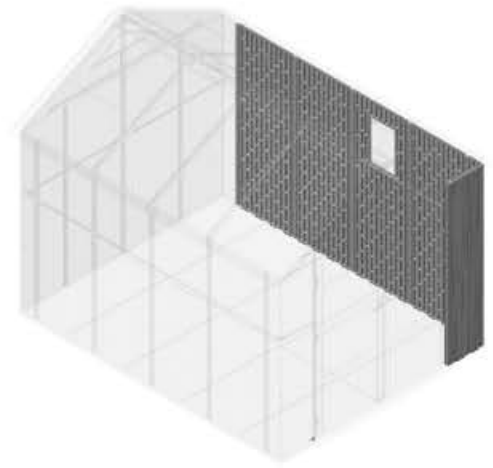

6



A7-pa x1

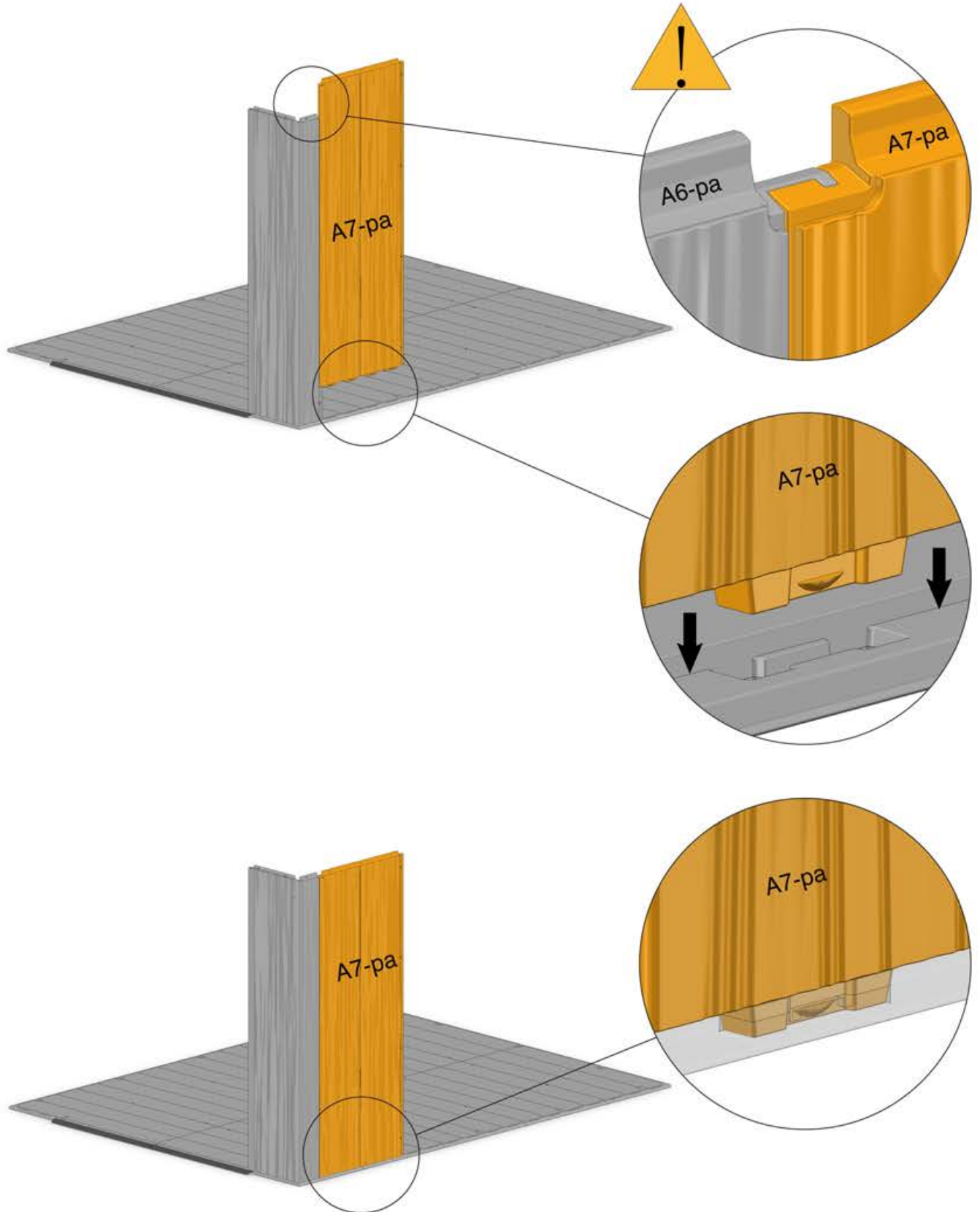

7



A8-pa x1



A7-pa x2

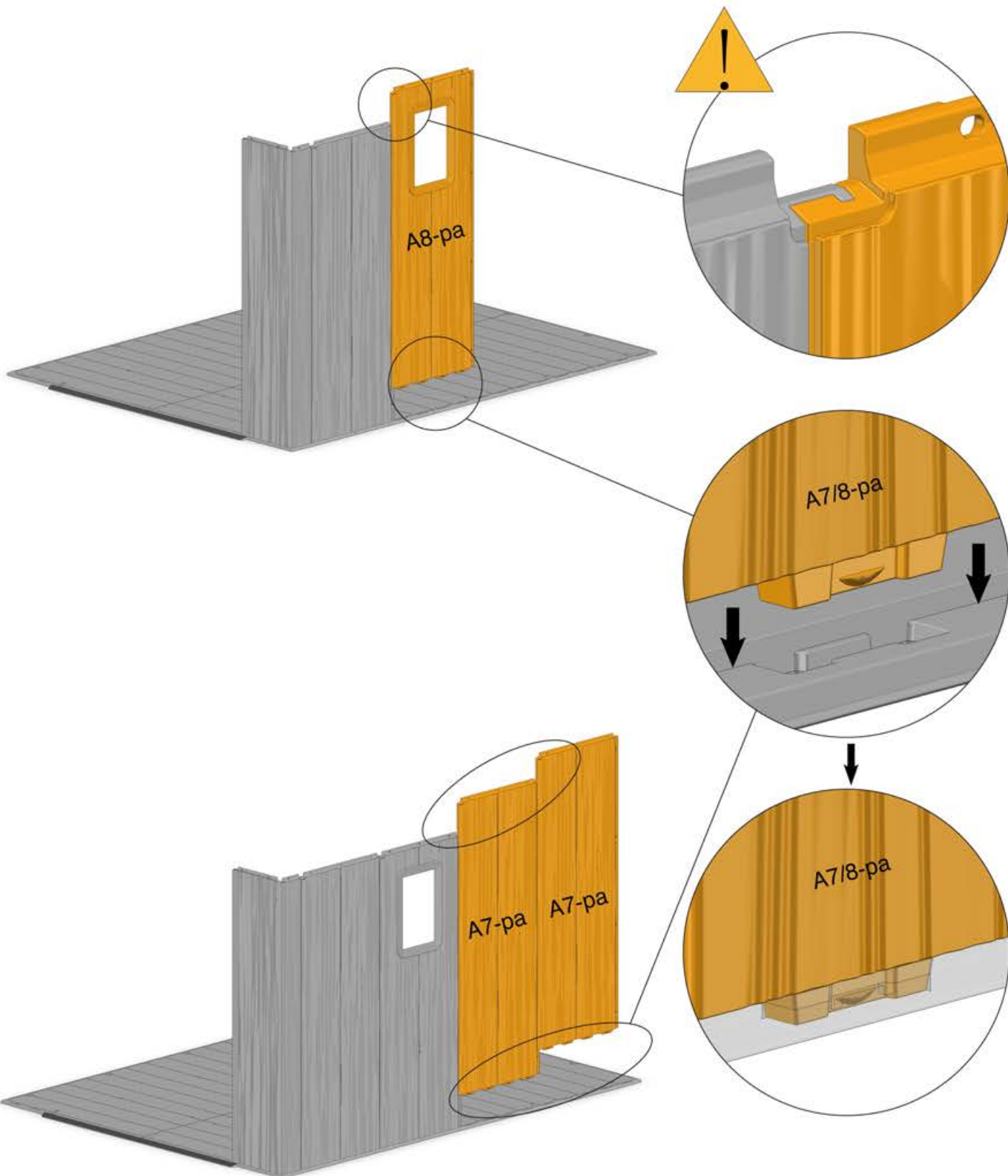

8

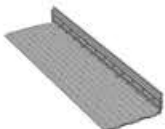

A9-pa x1

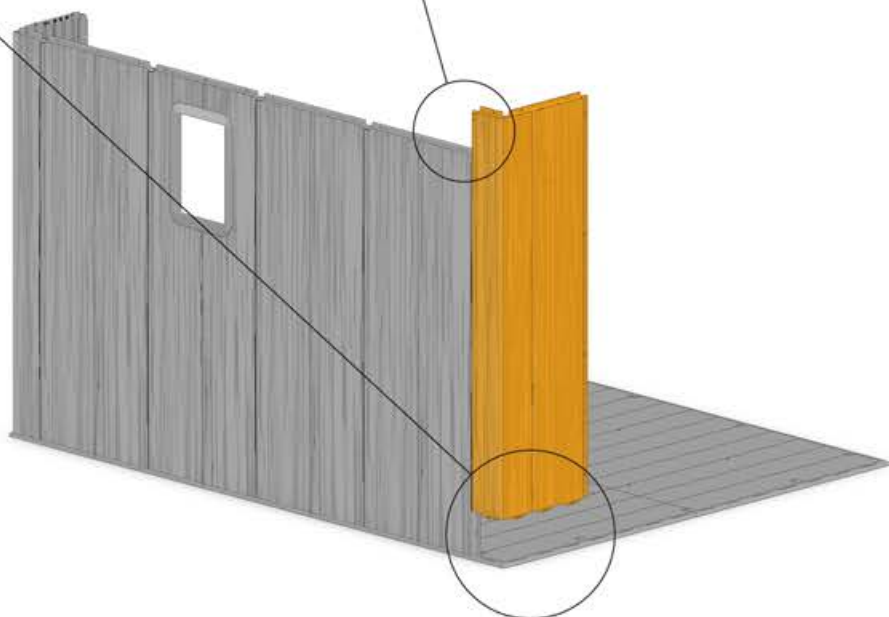
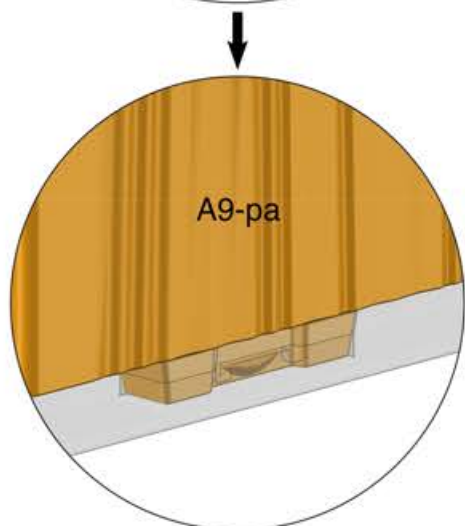
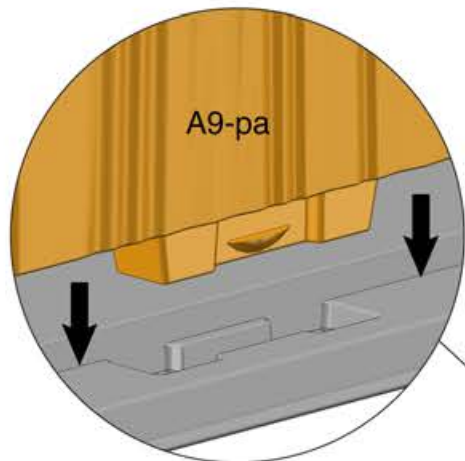
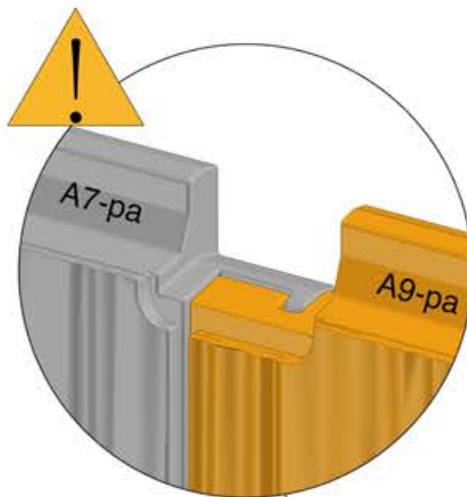
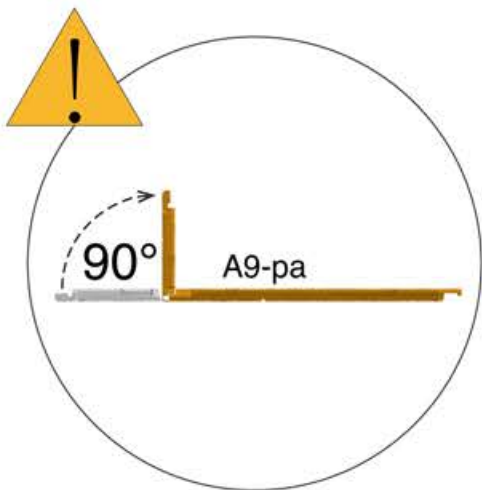
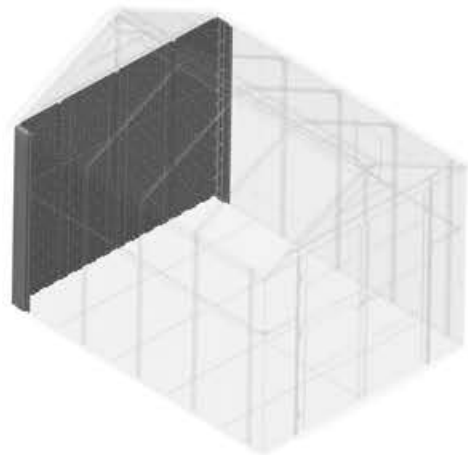

9





A7-pa x2

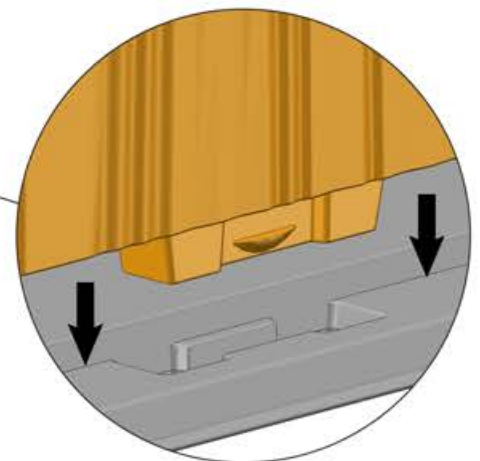
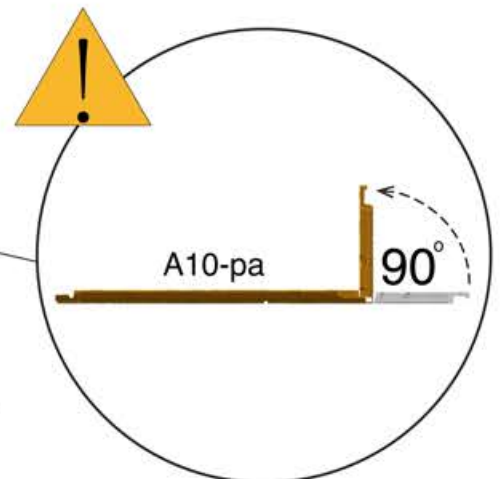
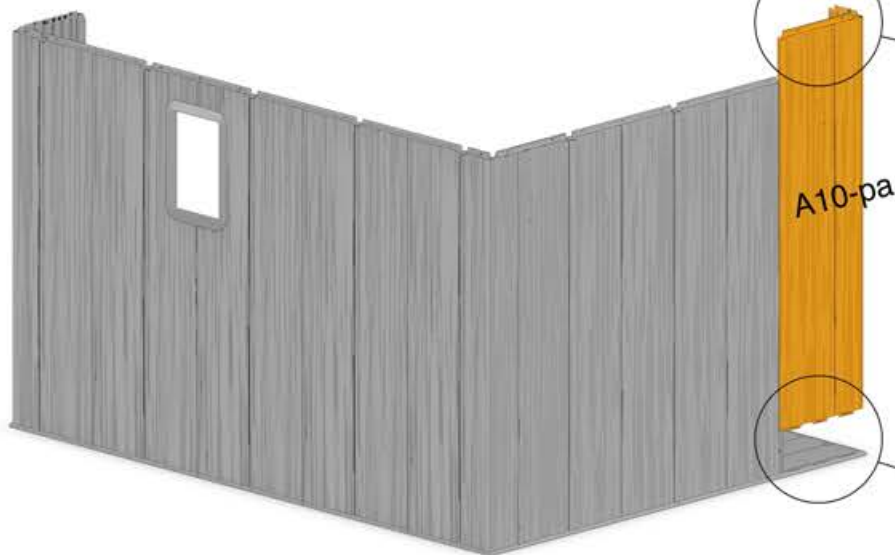
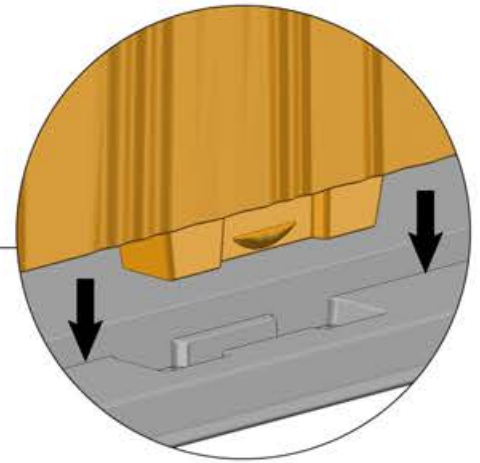
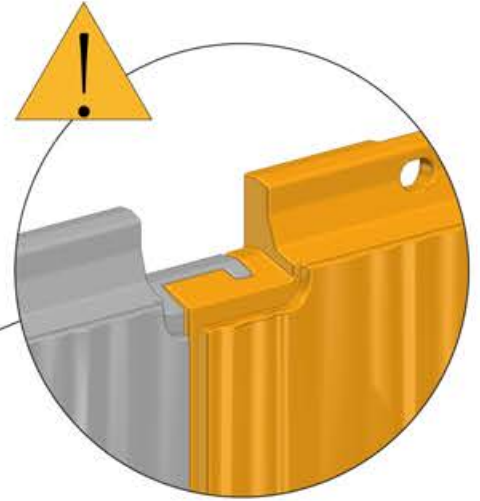
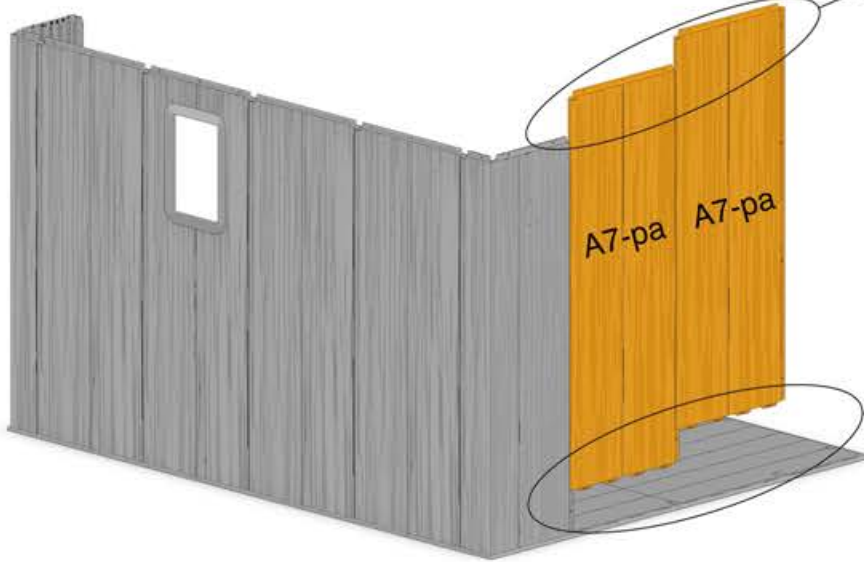

A10-pa x1



<h1>10</h1>	 <p>A7-pa x4</p>	 <p>A11-pa x1</p>
-------------	---	---

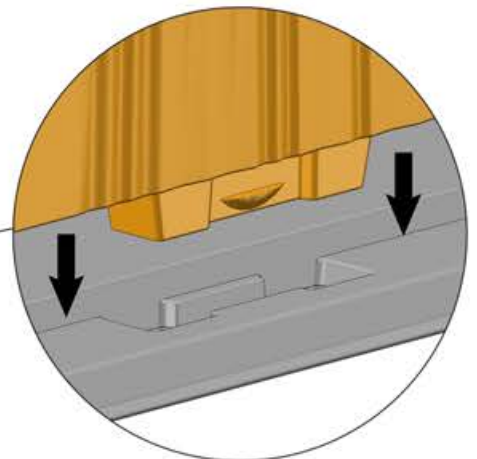
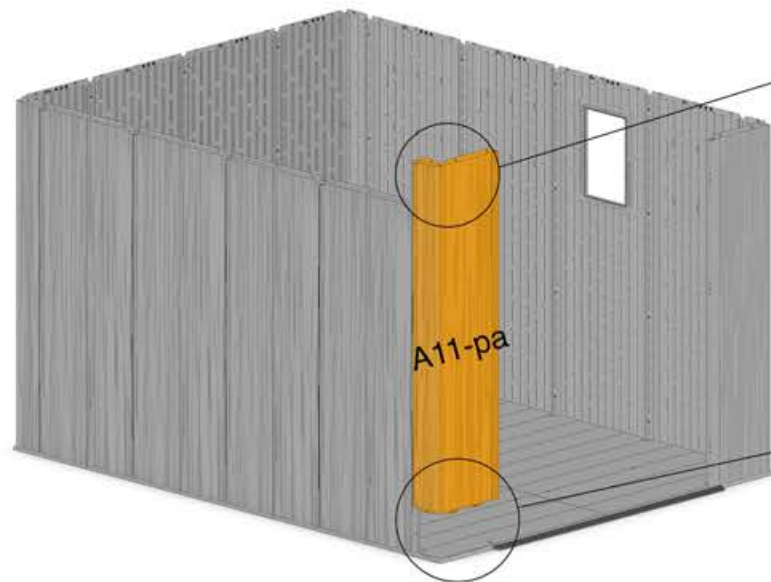
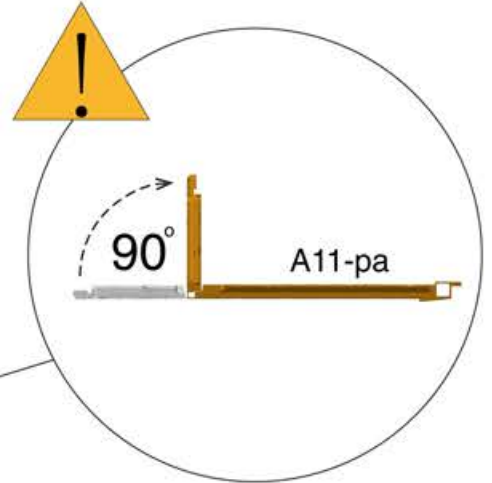
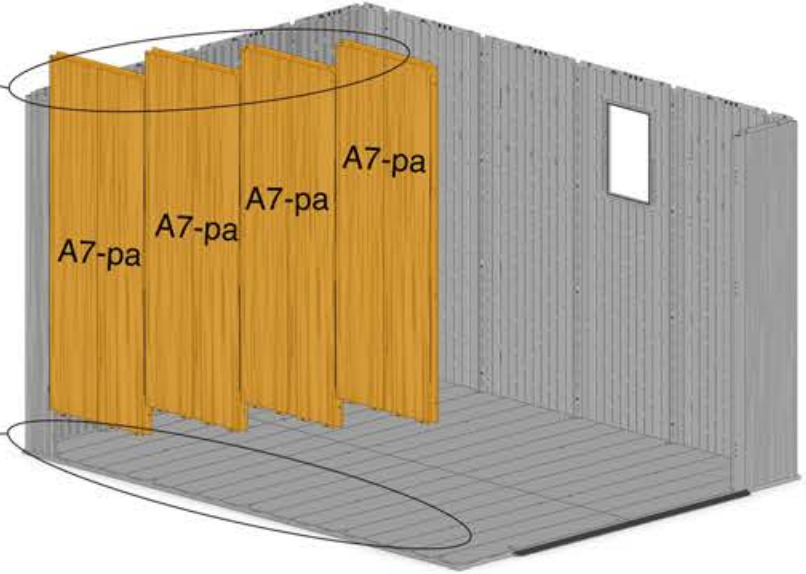
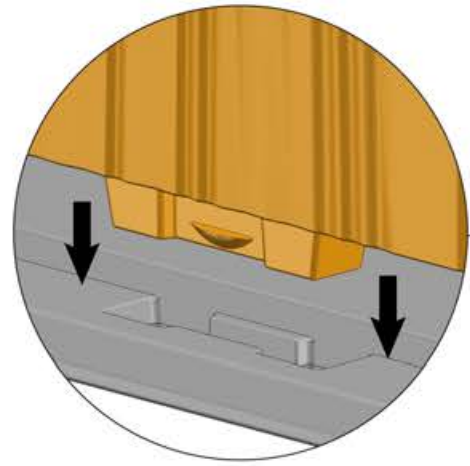
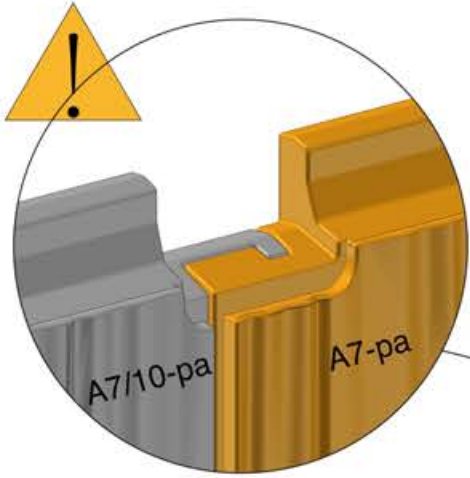
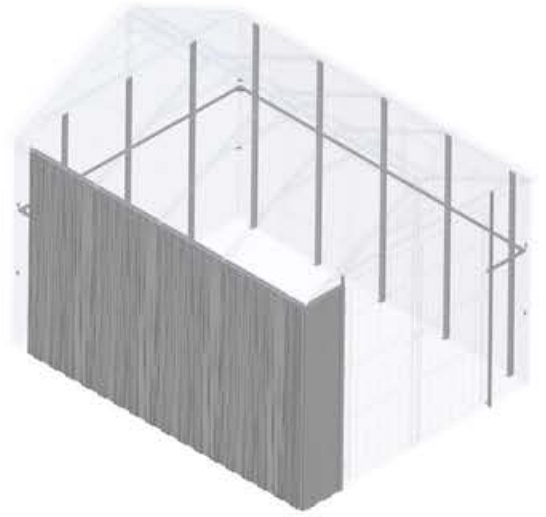

11



A30-pa x8



C54-pa x24

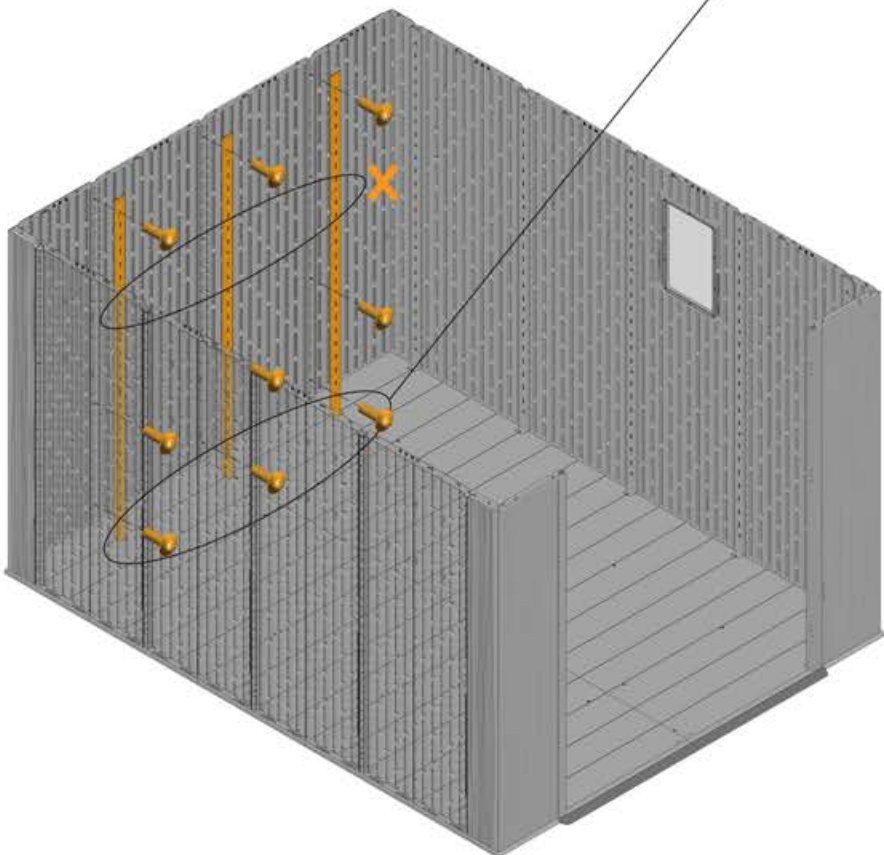
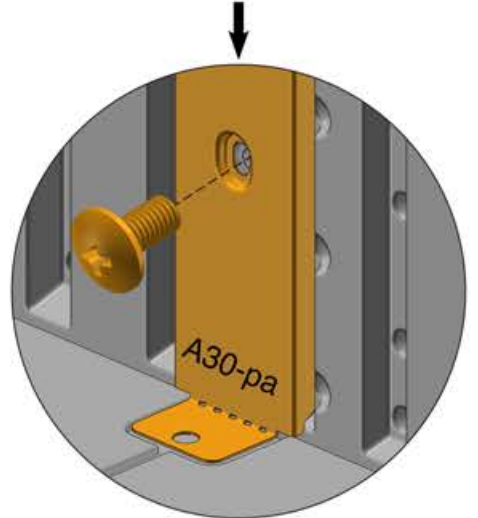
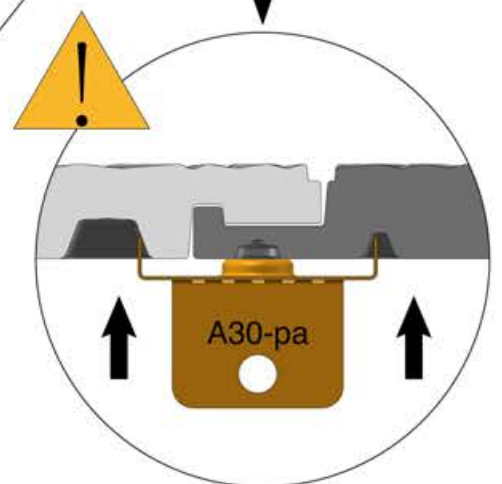
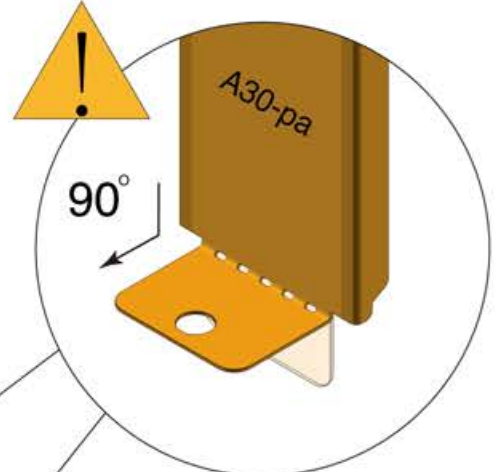
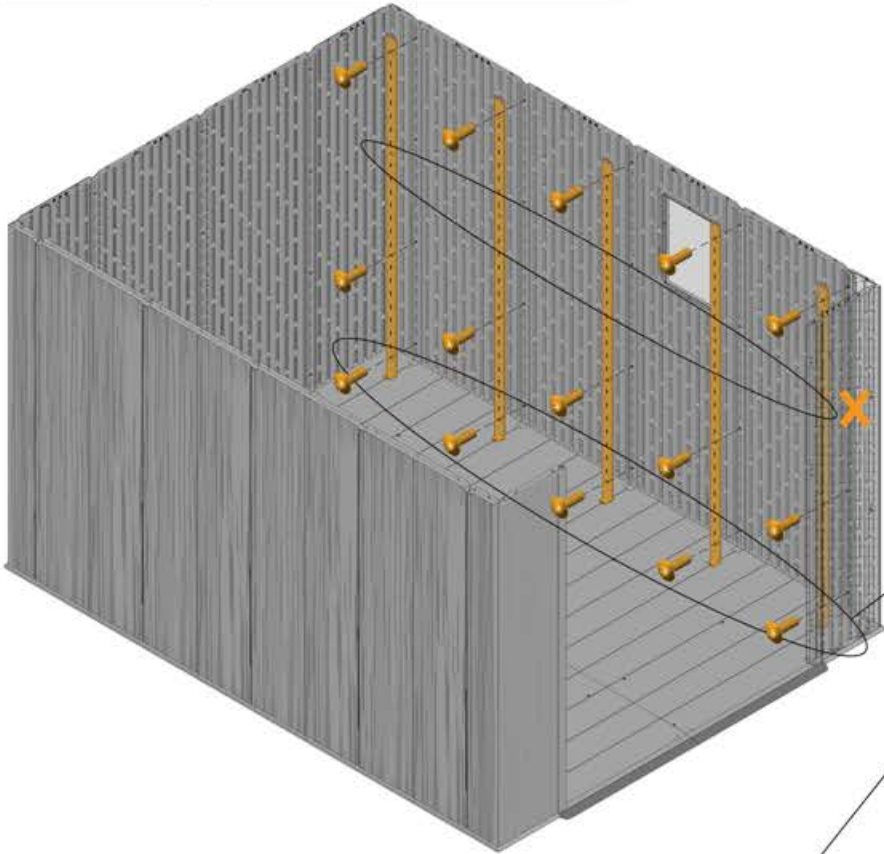

12



A30-pa x5



C54-pa x15

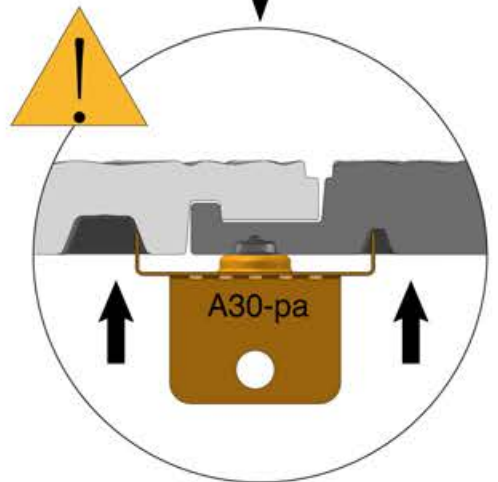
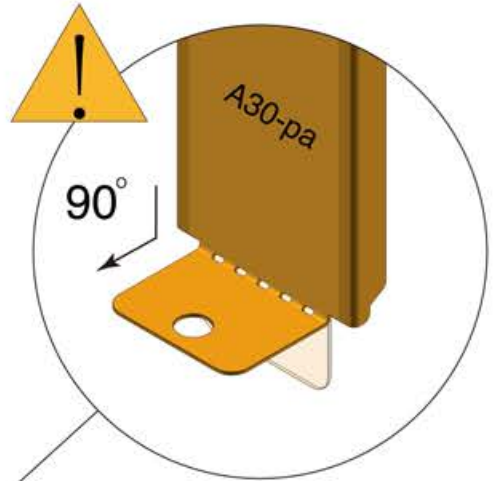
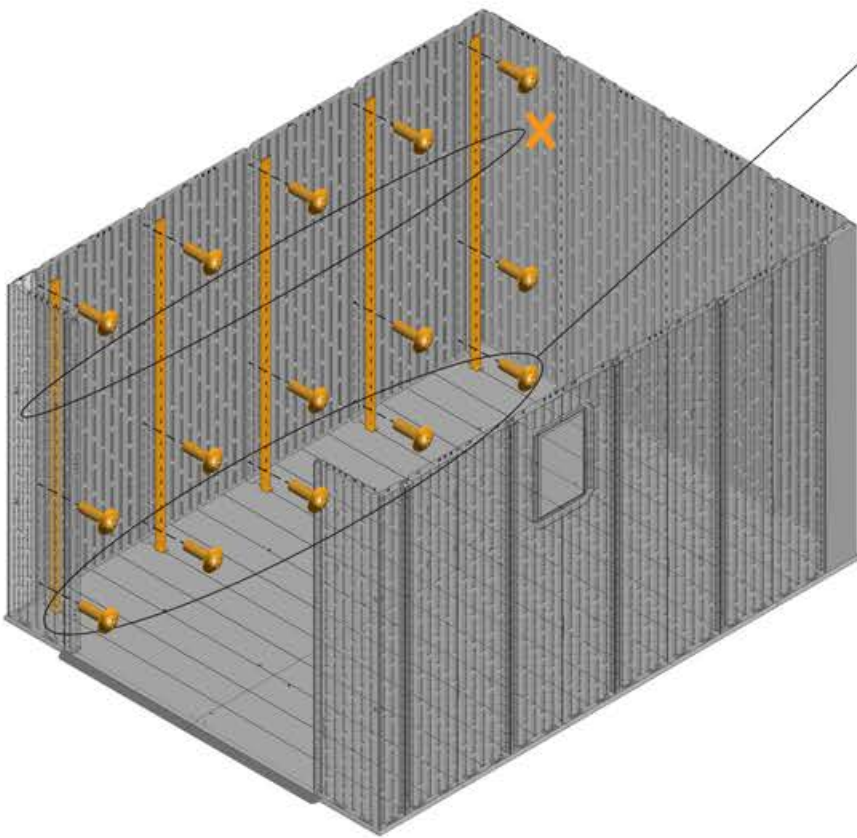

13

A46-pa x1

C47-pa x2

C47a-pa x2

C55-pa x13

C51-pa x8

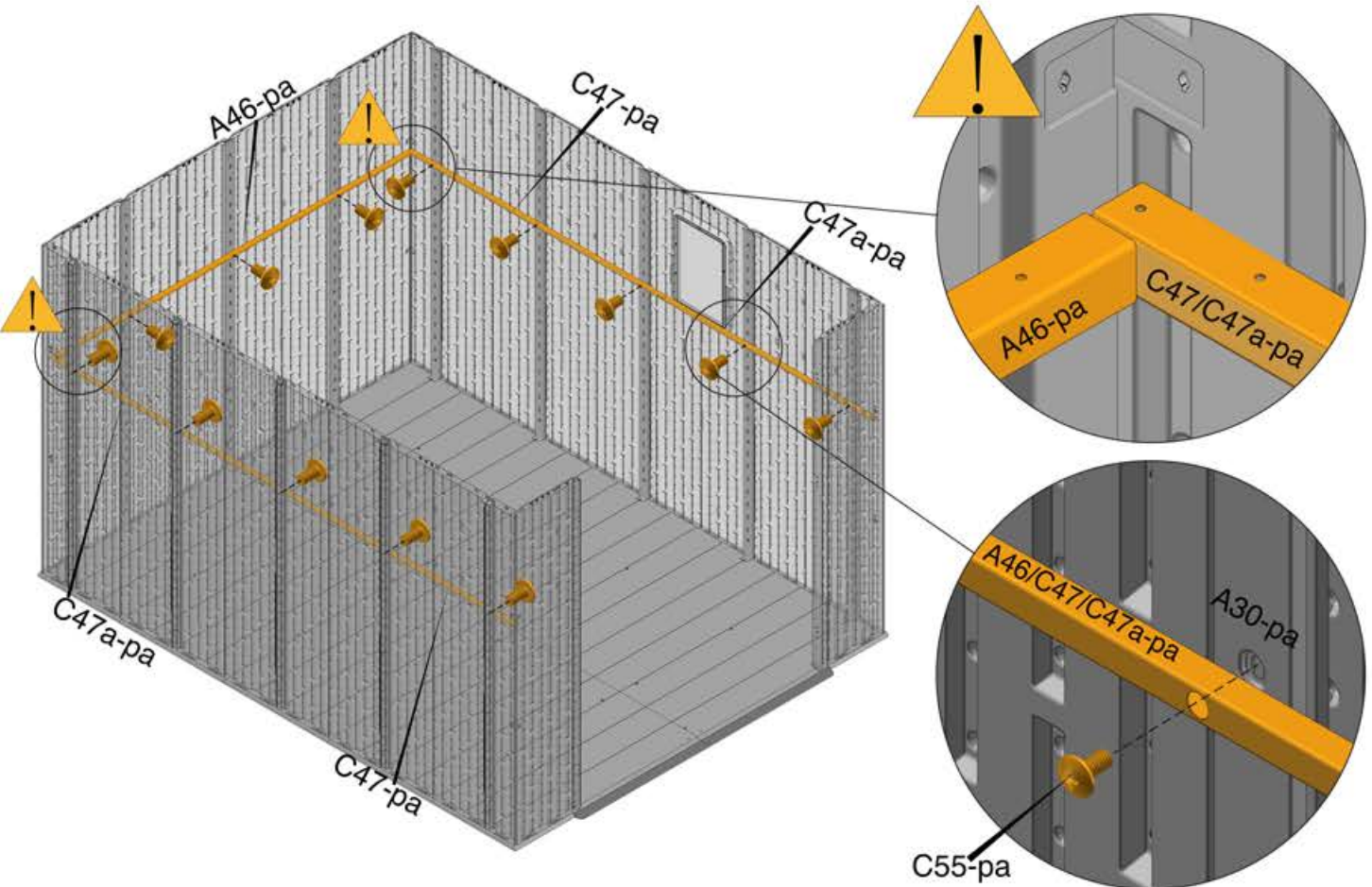
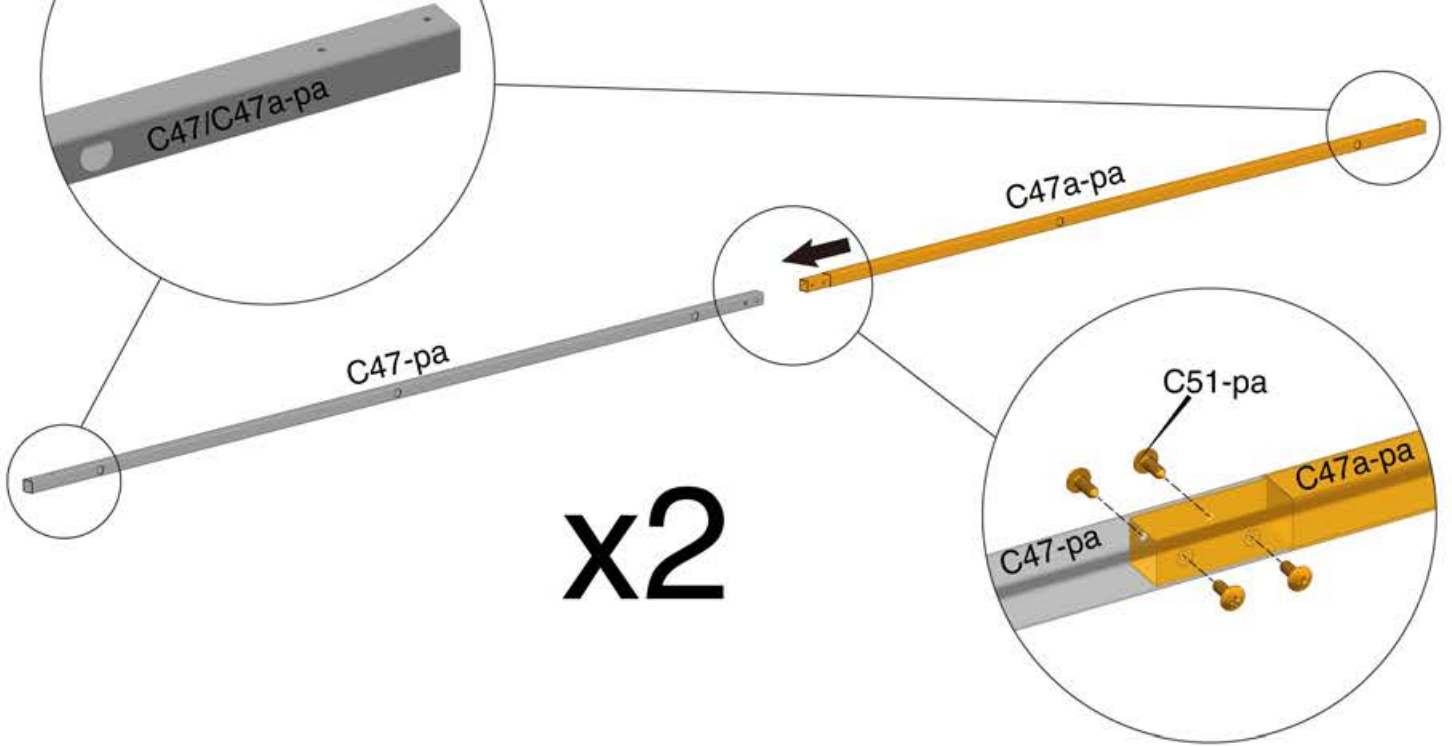

14



Ab-4 x4



C51-pa x10

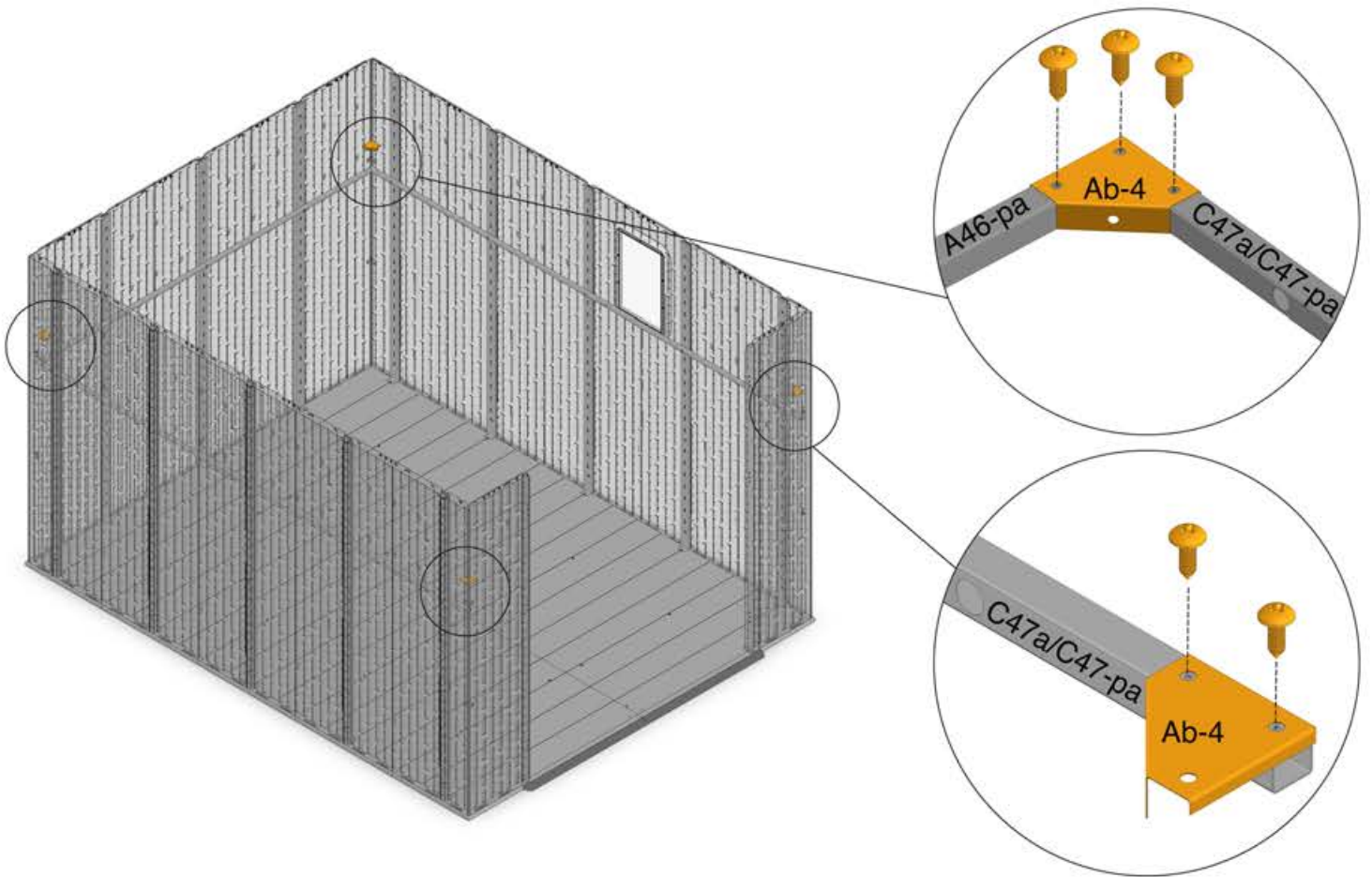

15

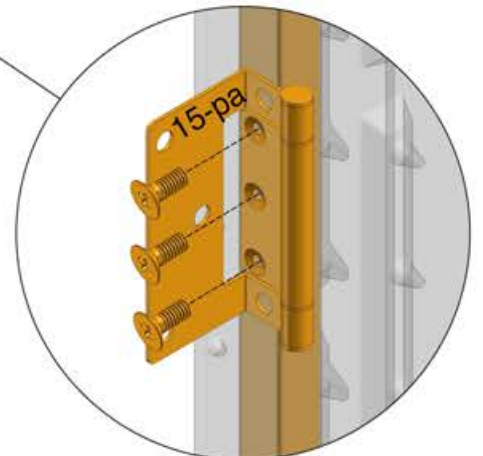
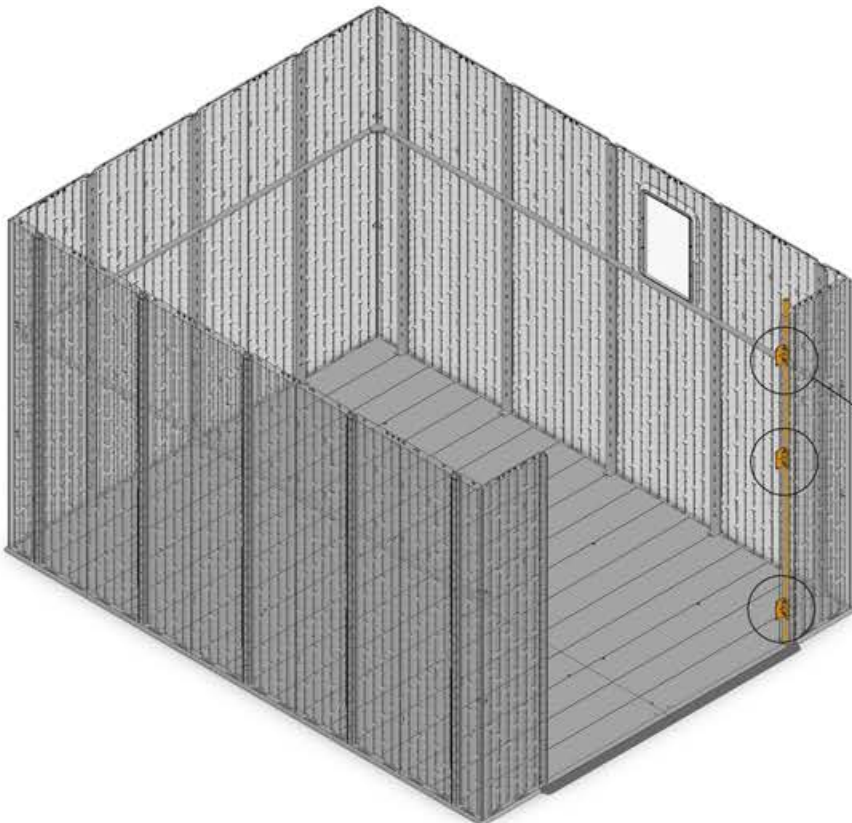
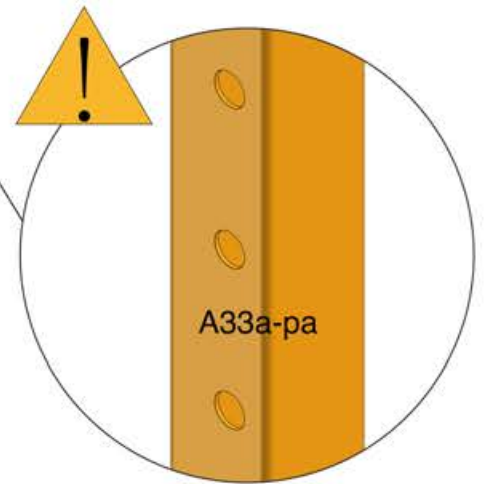
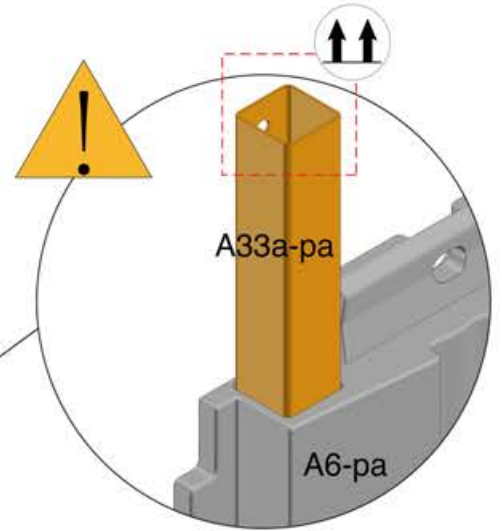
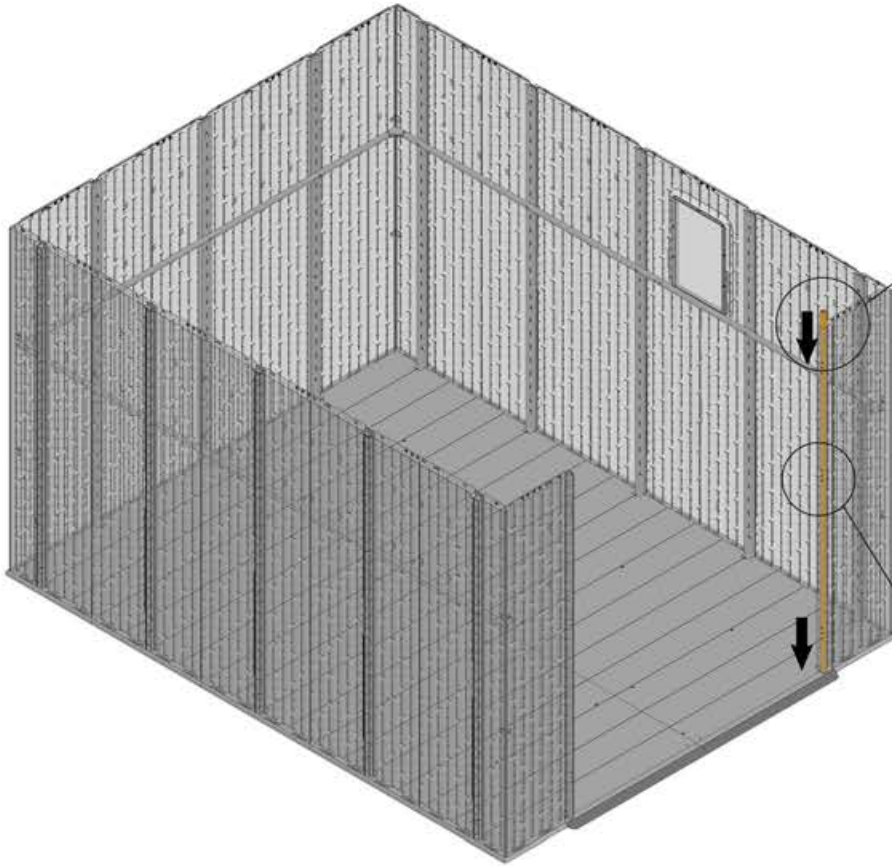

16

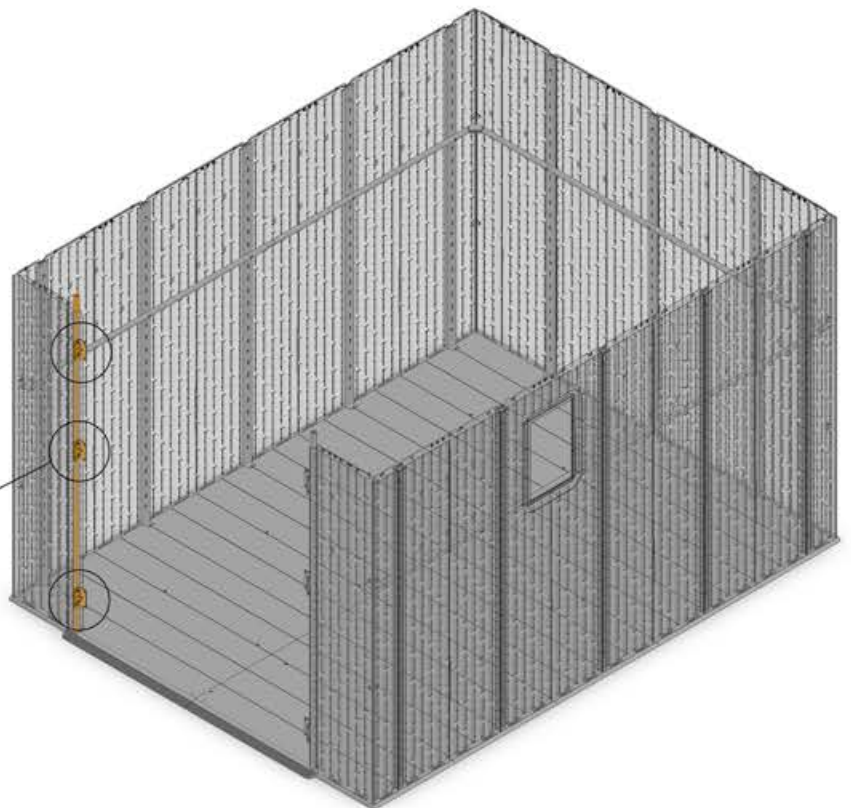
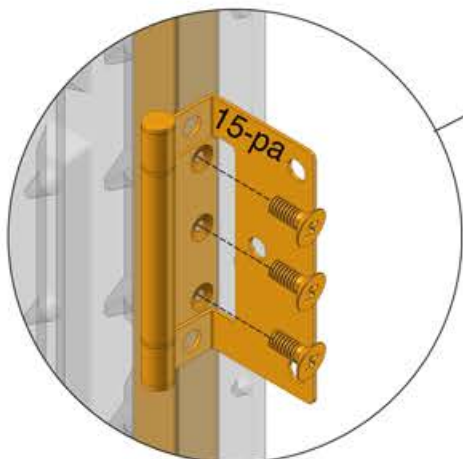
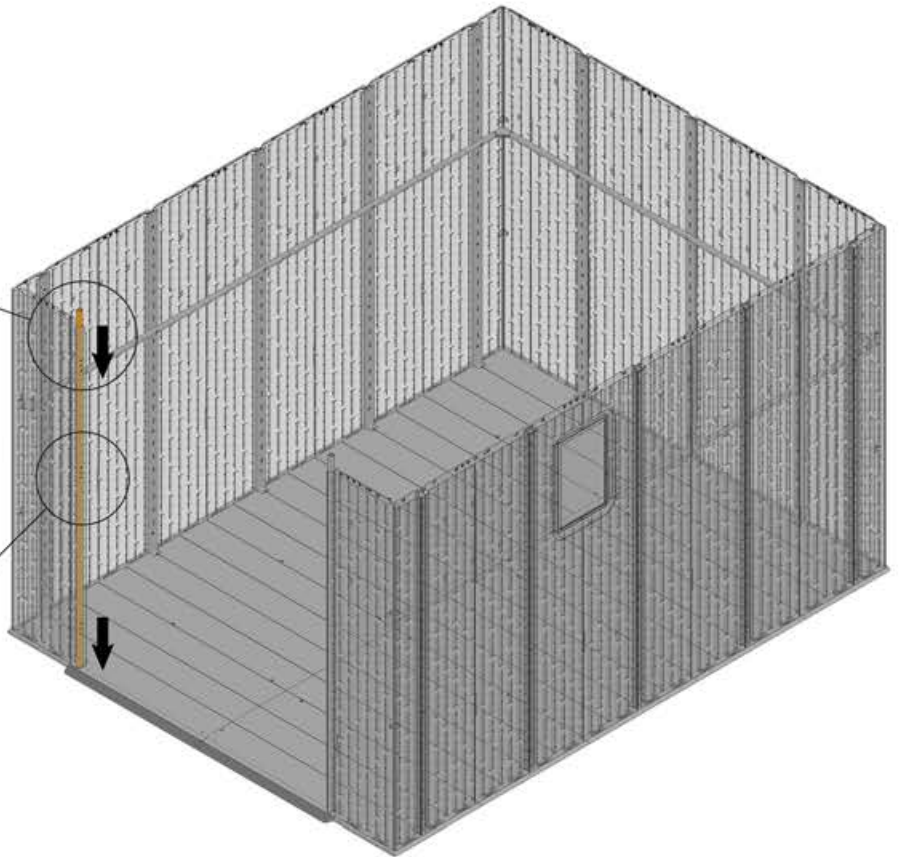
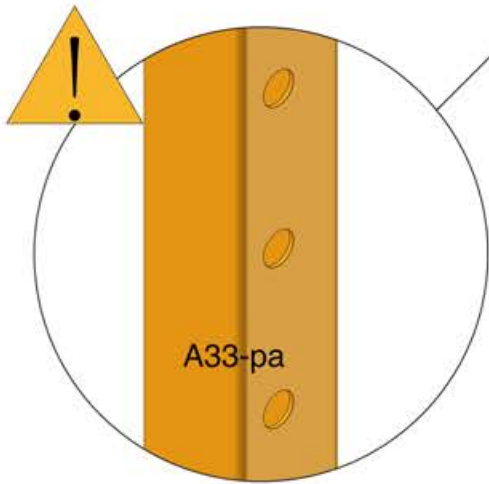
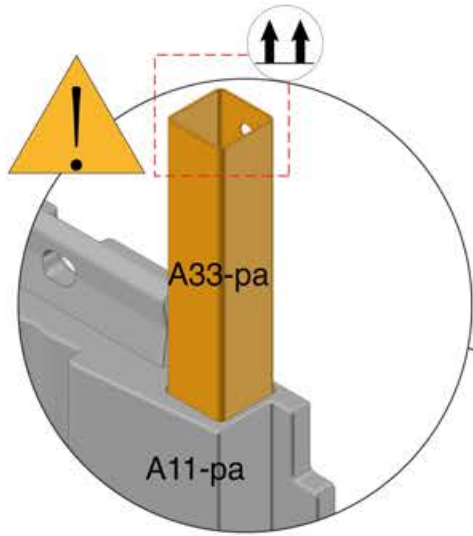

17



A48-pa x2



21-pa x2



16-pa x10



C51-pa x2



C52-pa x4



C58-pa x16

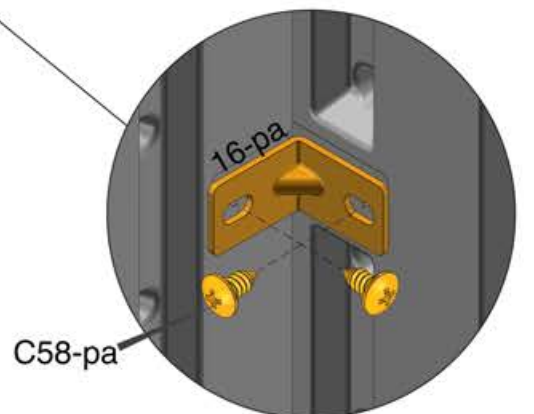
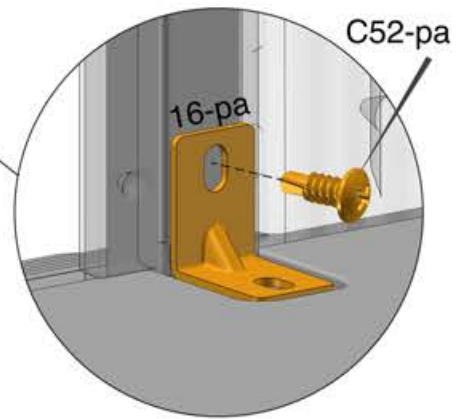
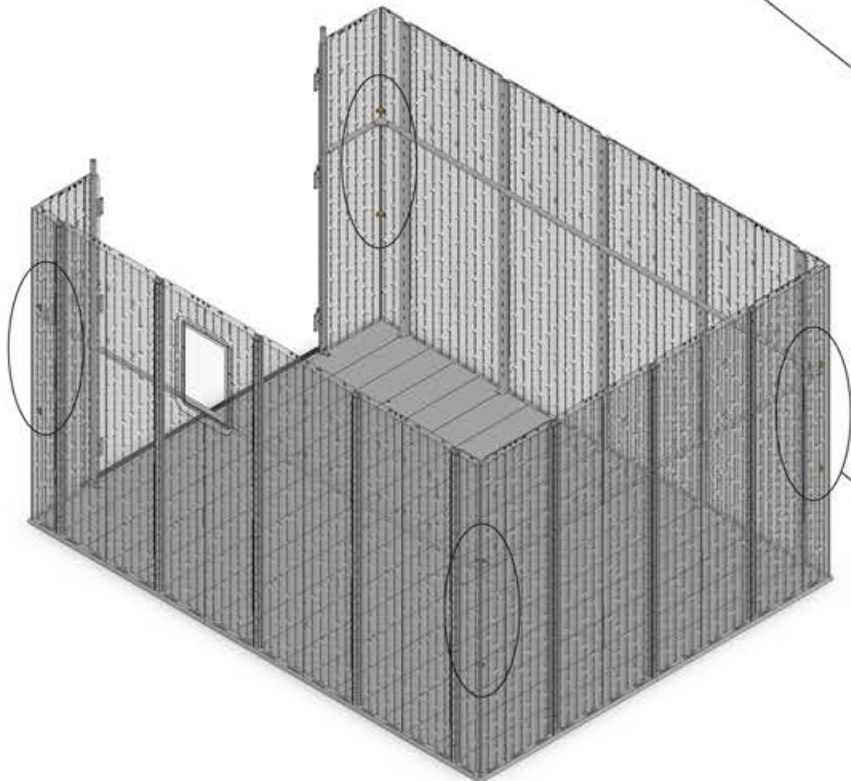
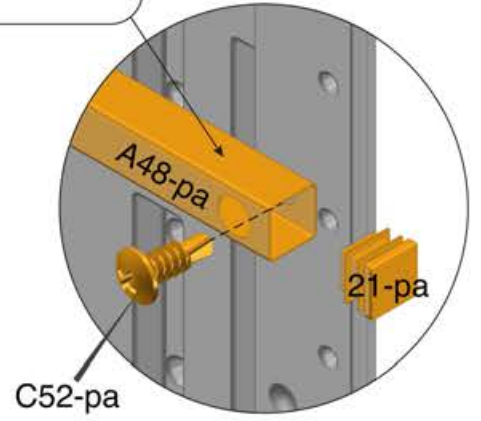
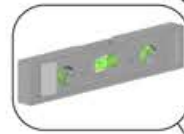
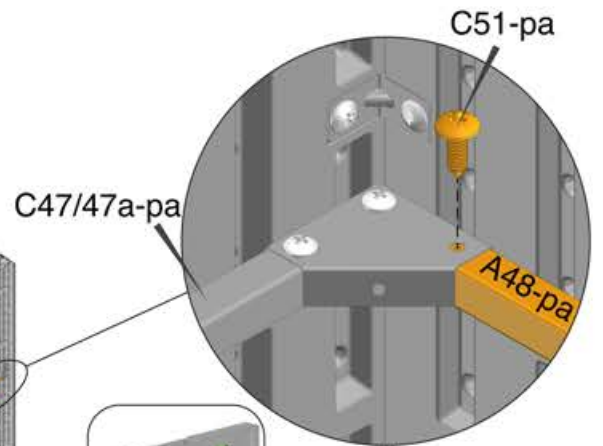
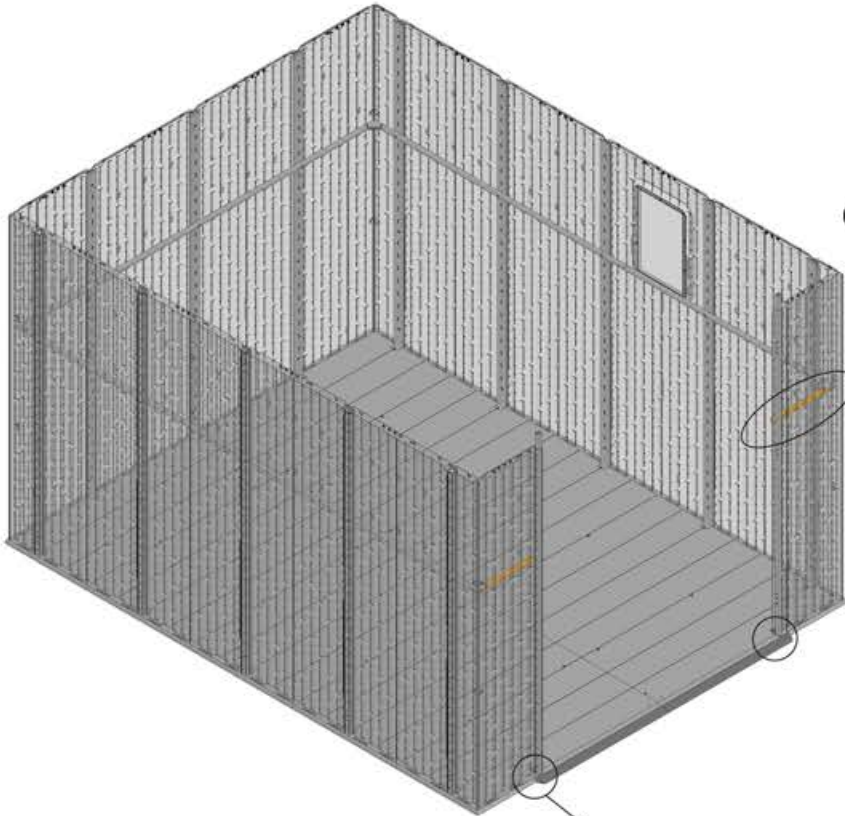

18



A43-pa x6



C58-pa x24

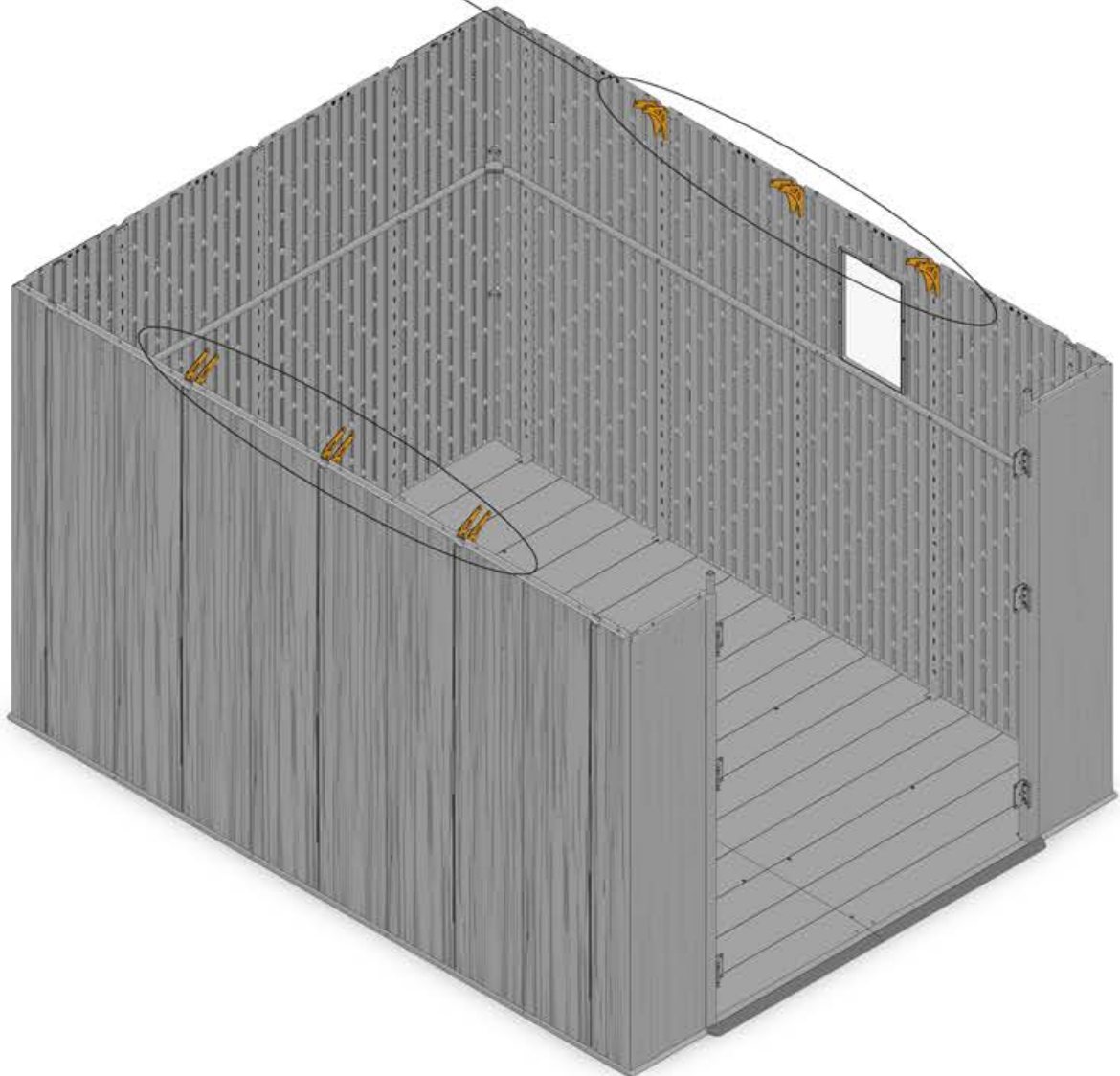
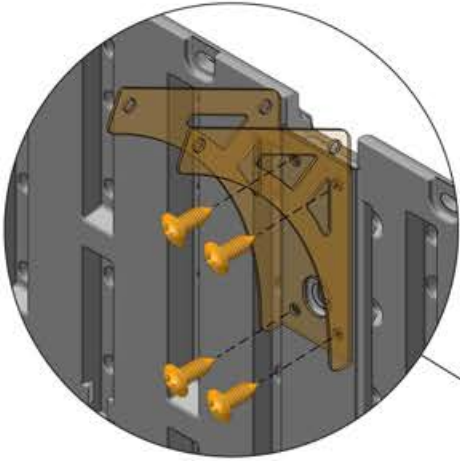

19

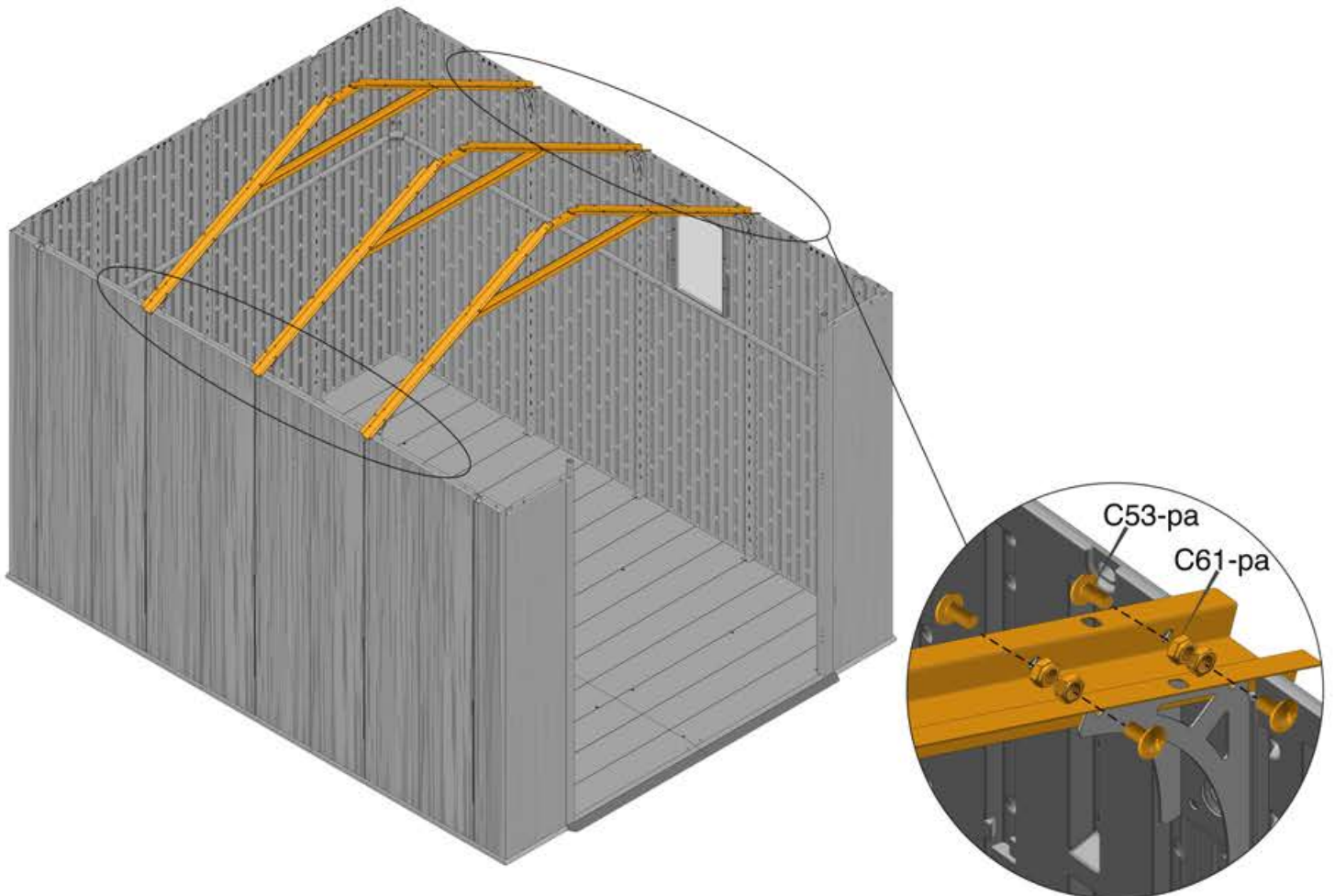
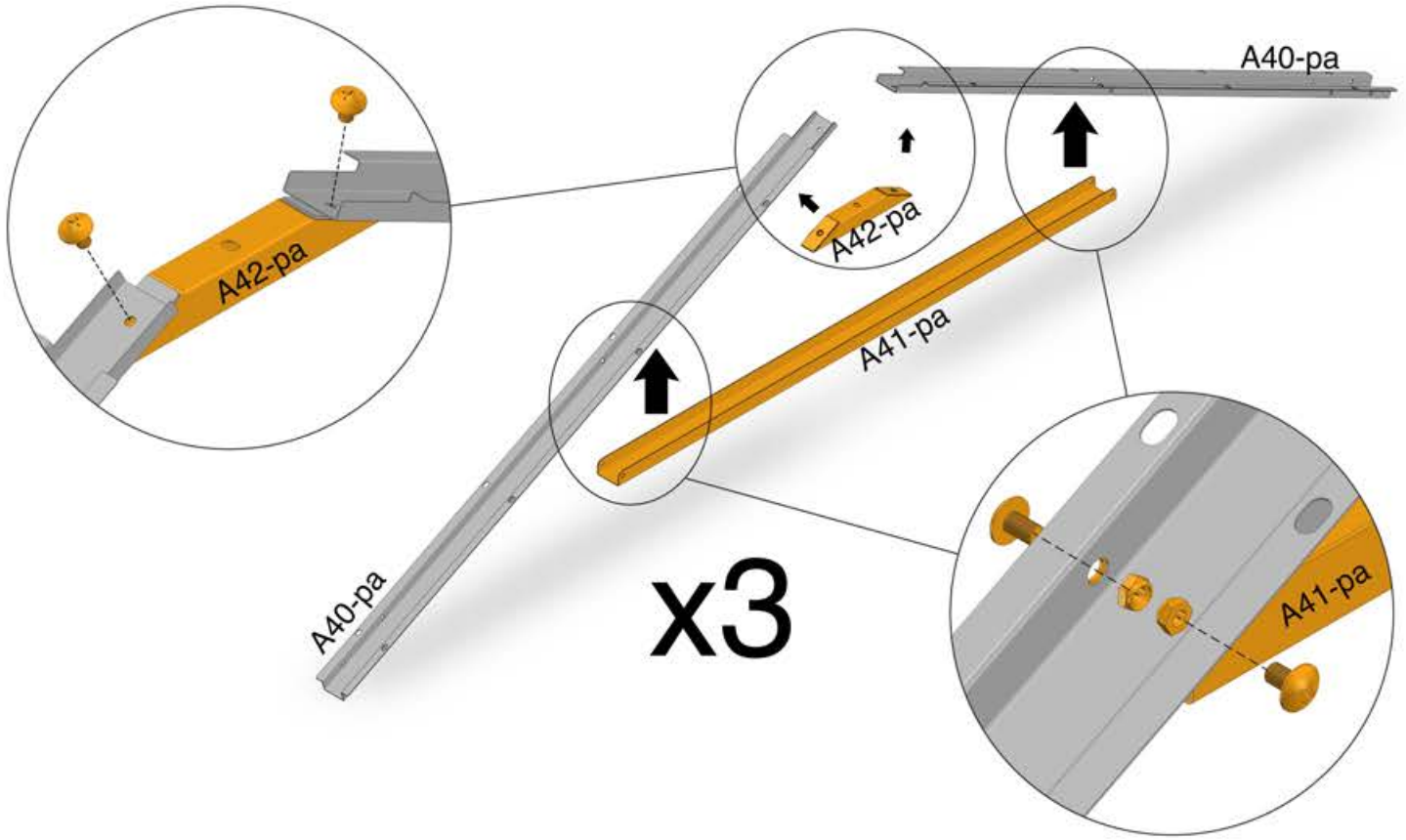
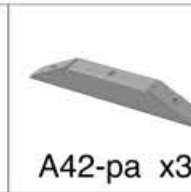
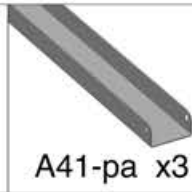
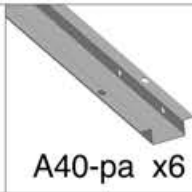

20



A12-pa x1



A13-pa x1



A24-pa x1



C54-pa x3



C51-pa x6

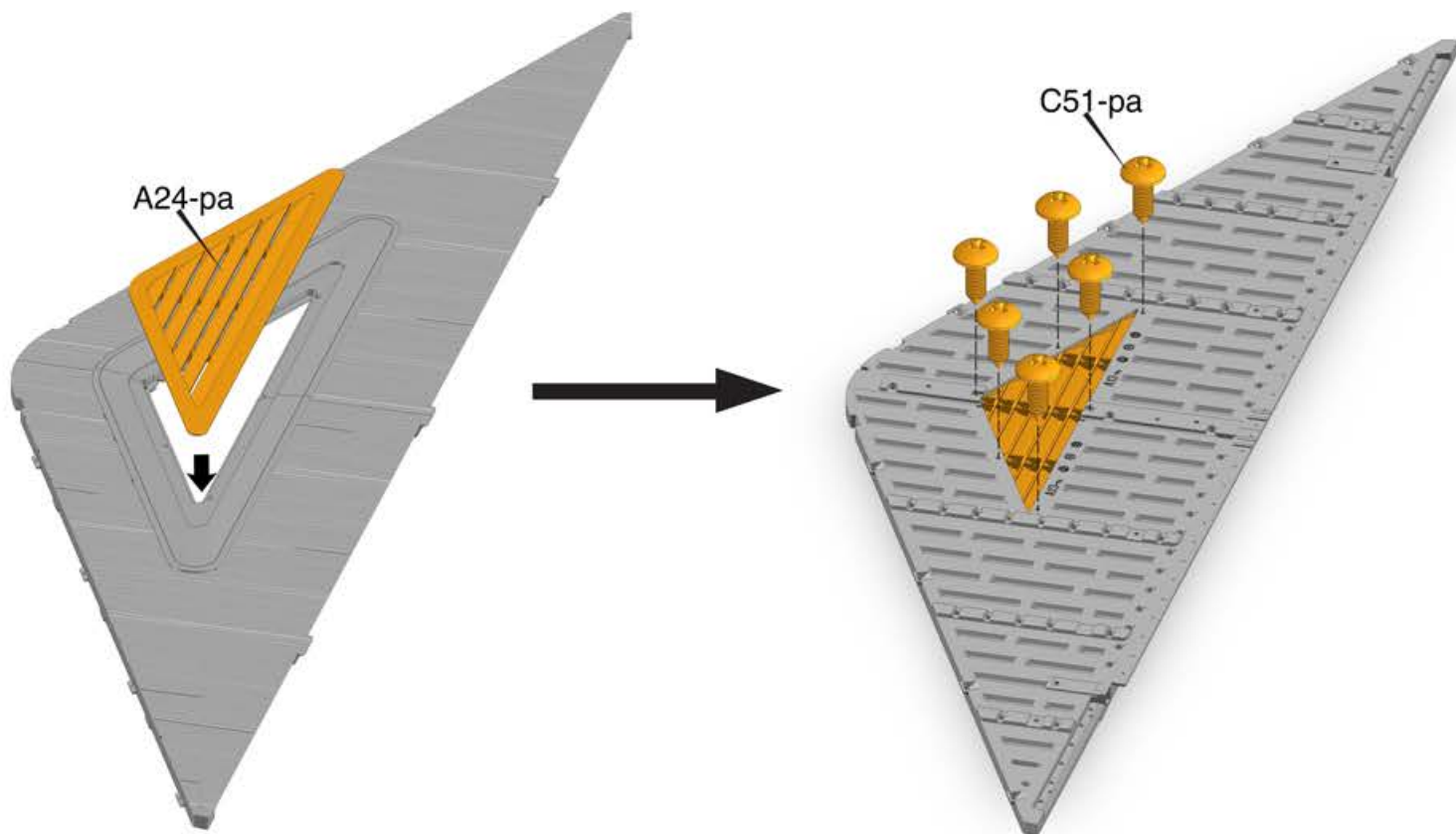
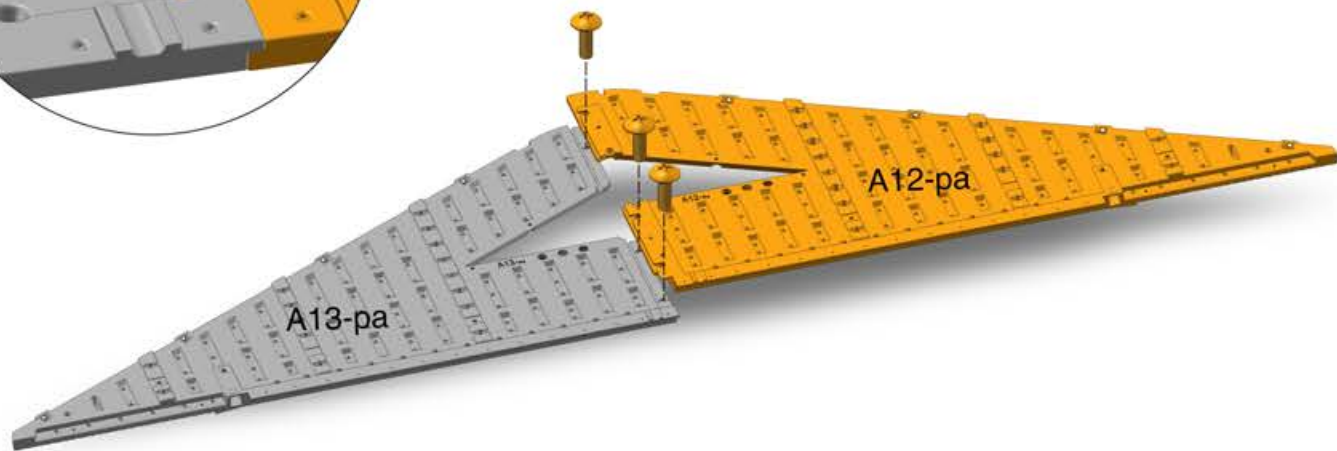
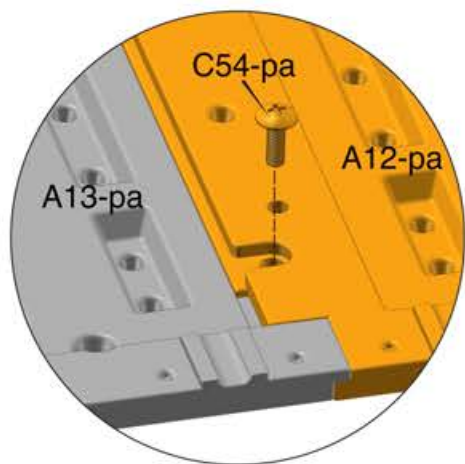

21

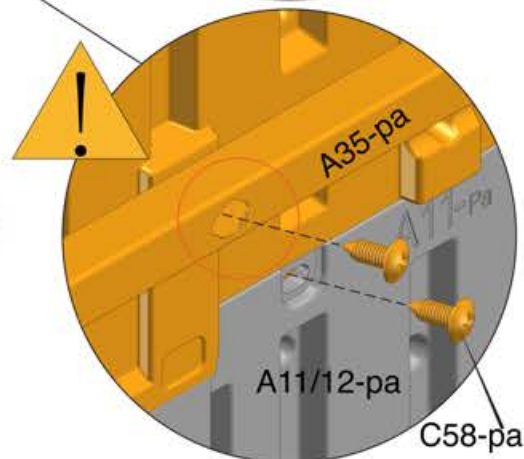
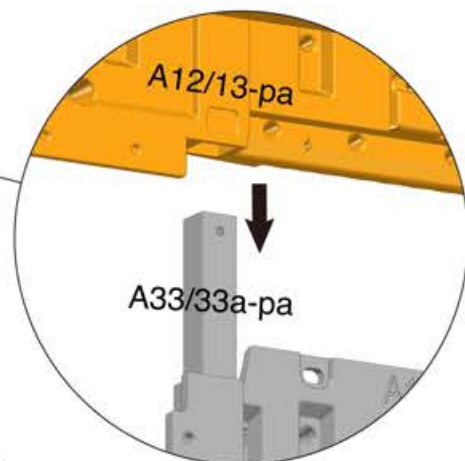
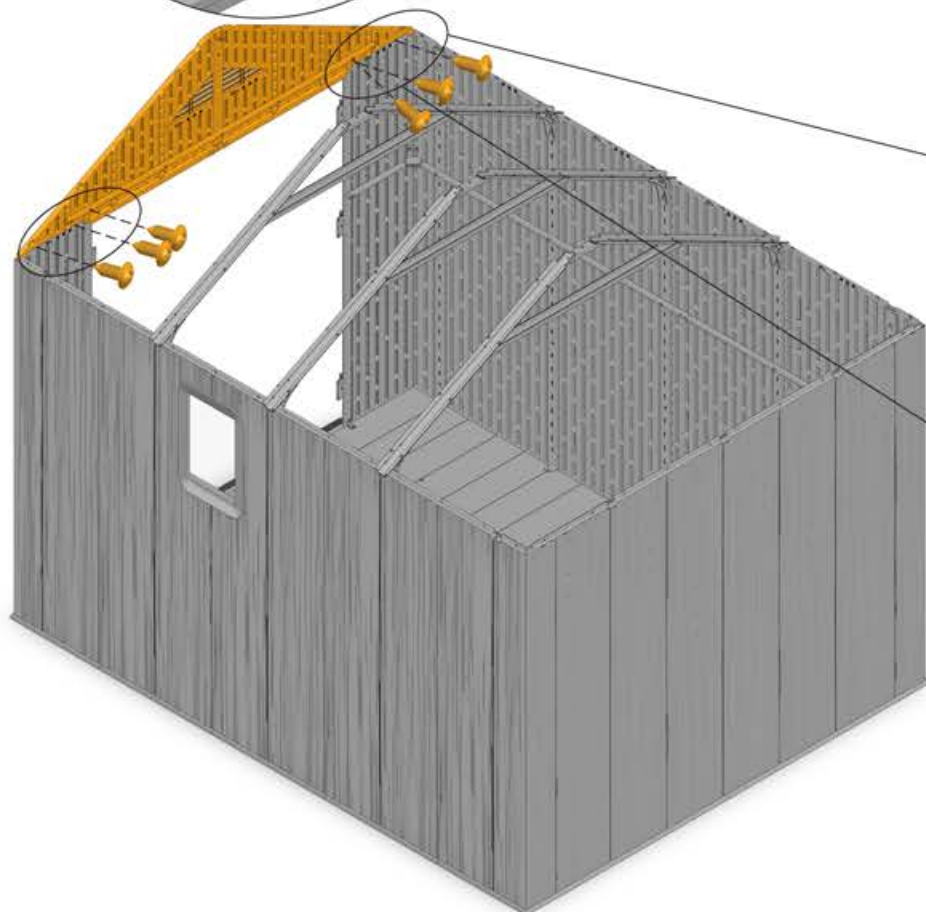
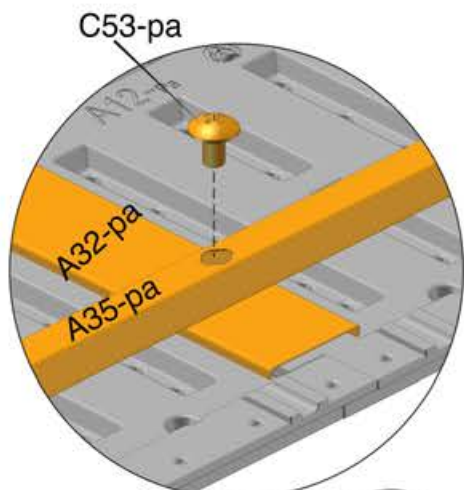
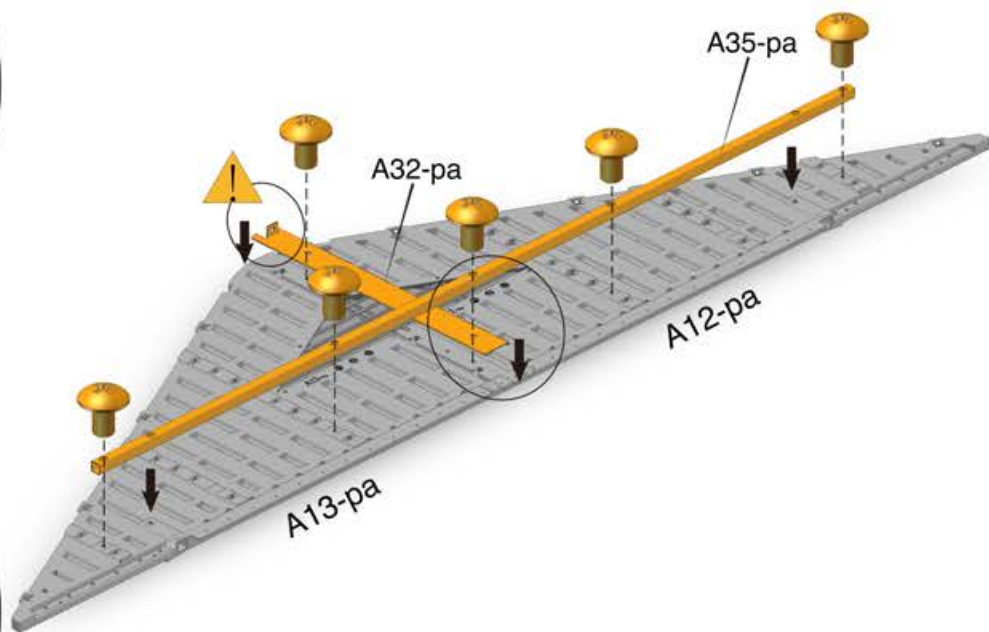
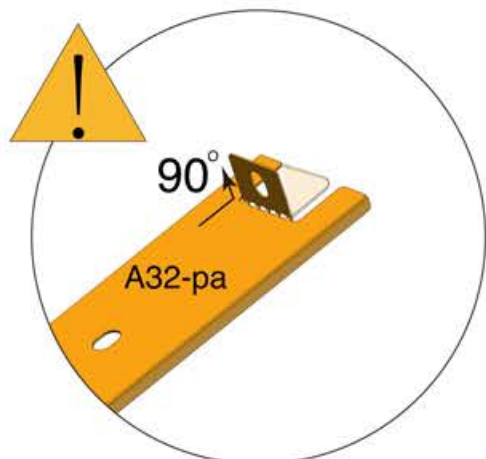

22



A14-pa x1



A15-pa x1



A24-pa x1



C54-pa x3



C51-pa x6

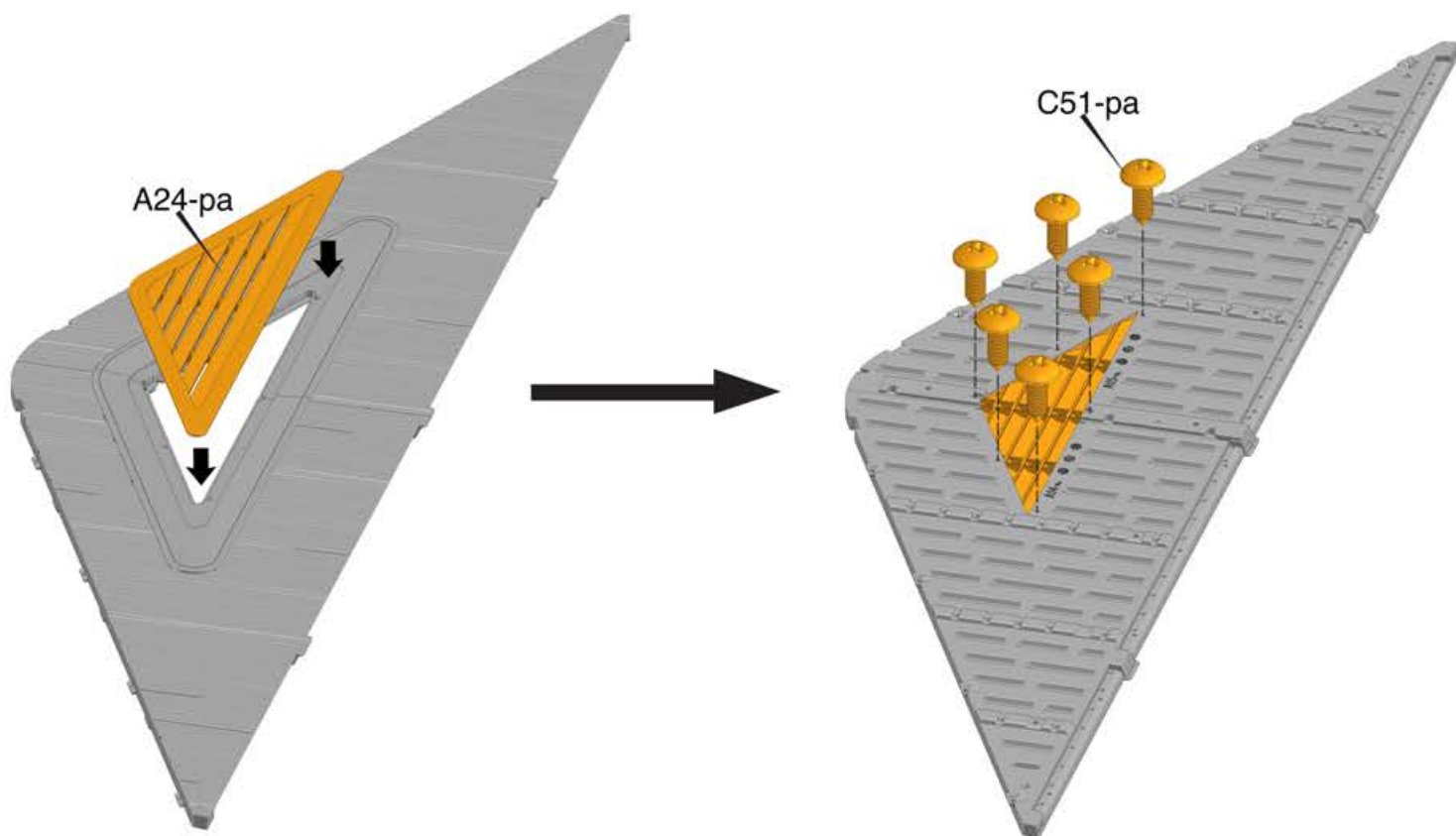
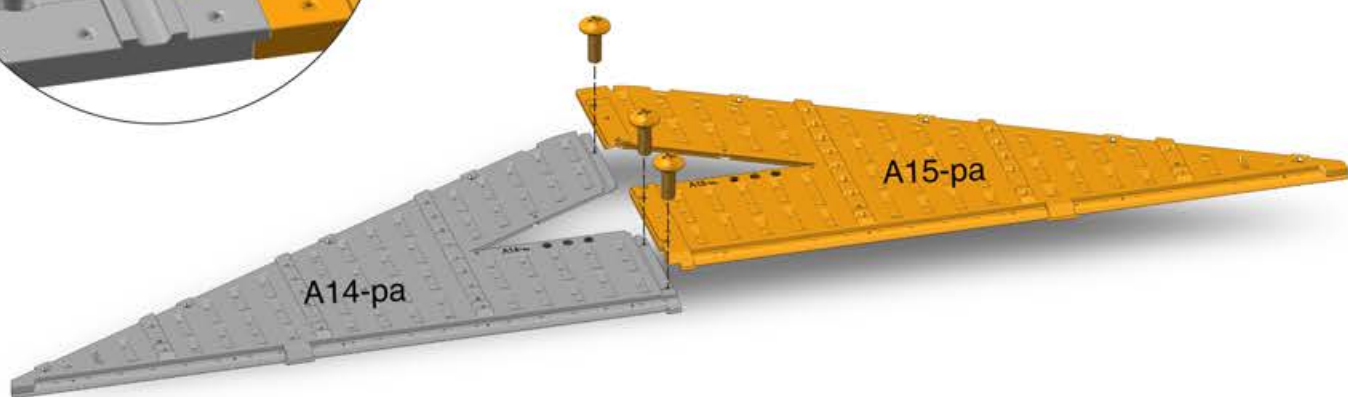
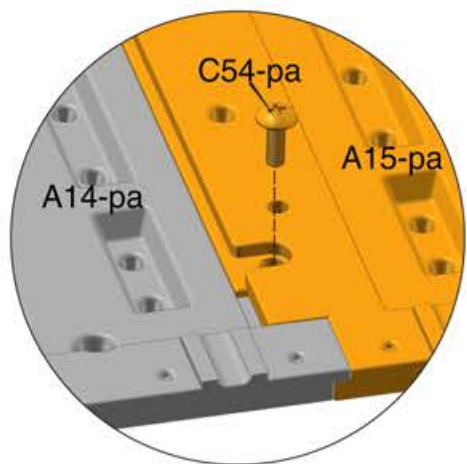

23

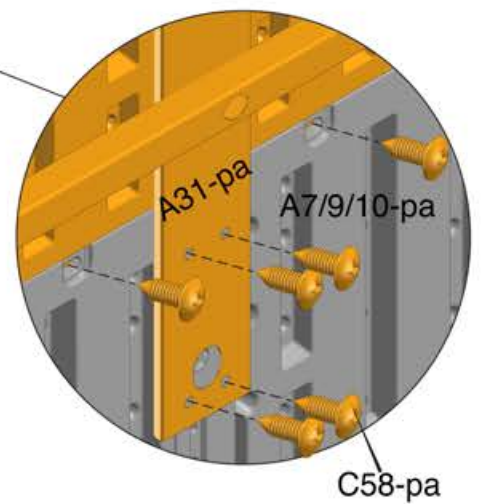
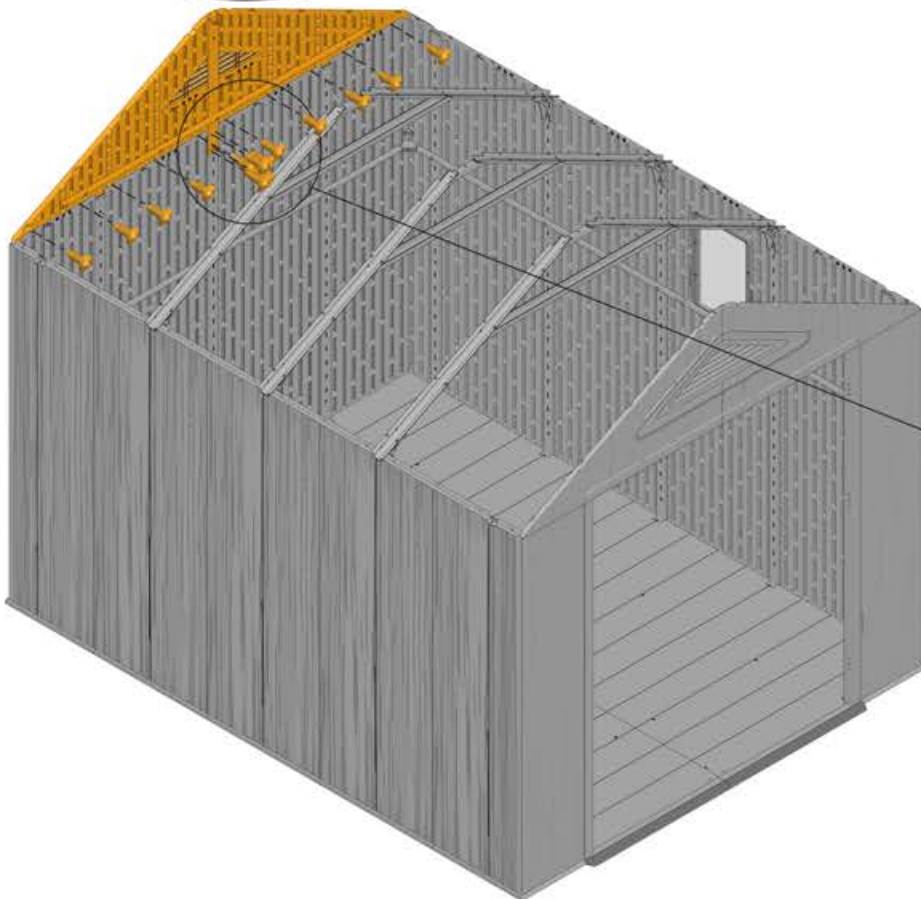
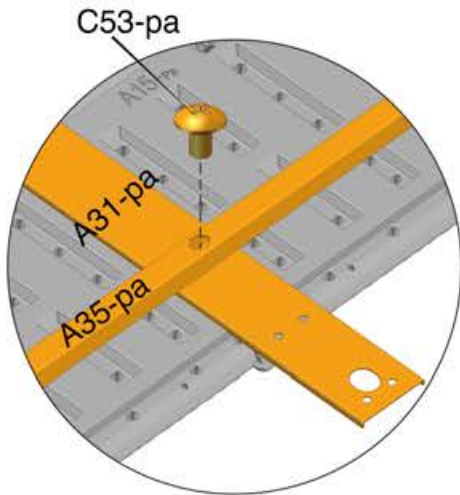
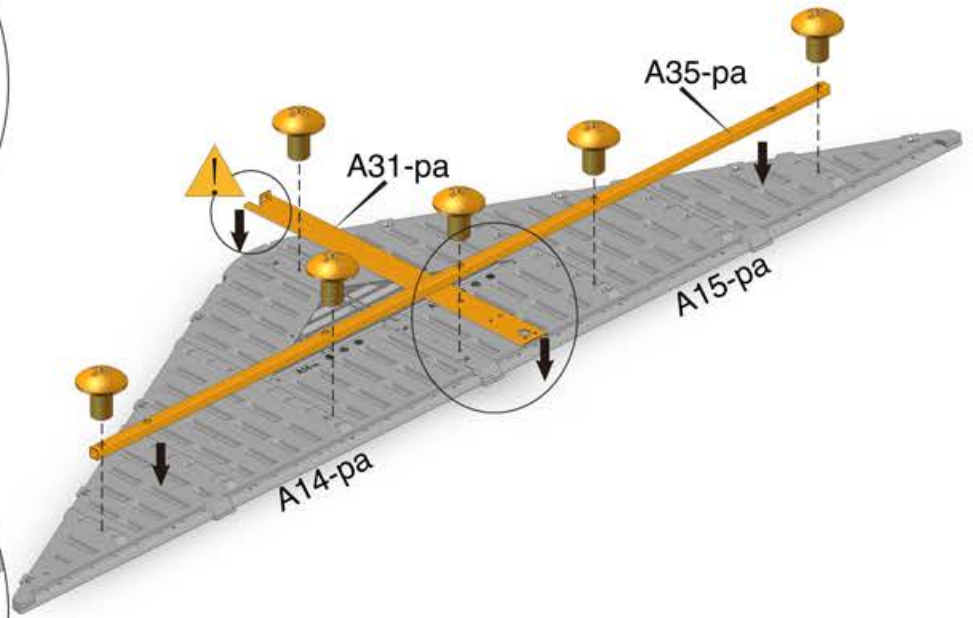
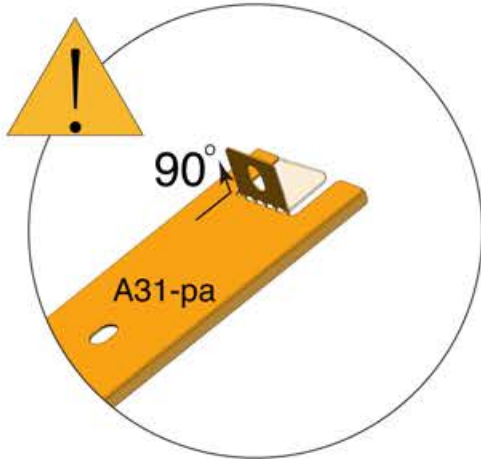

24

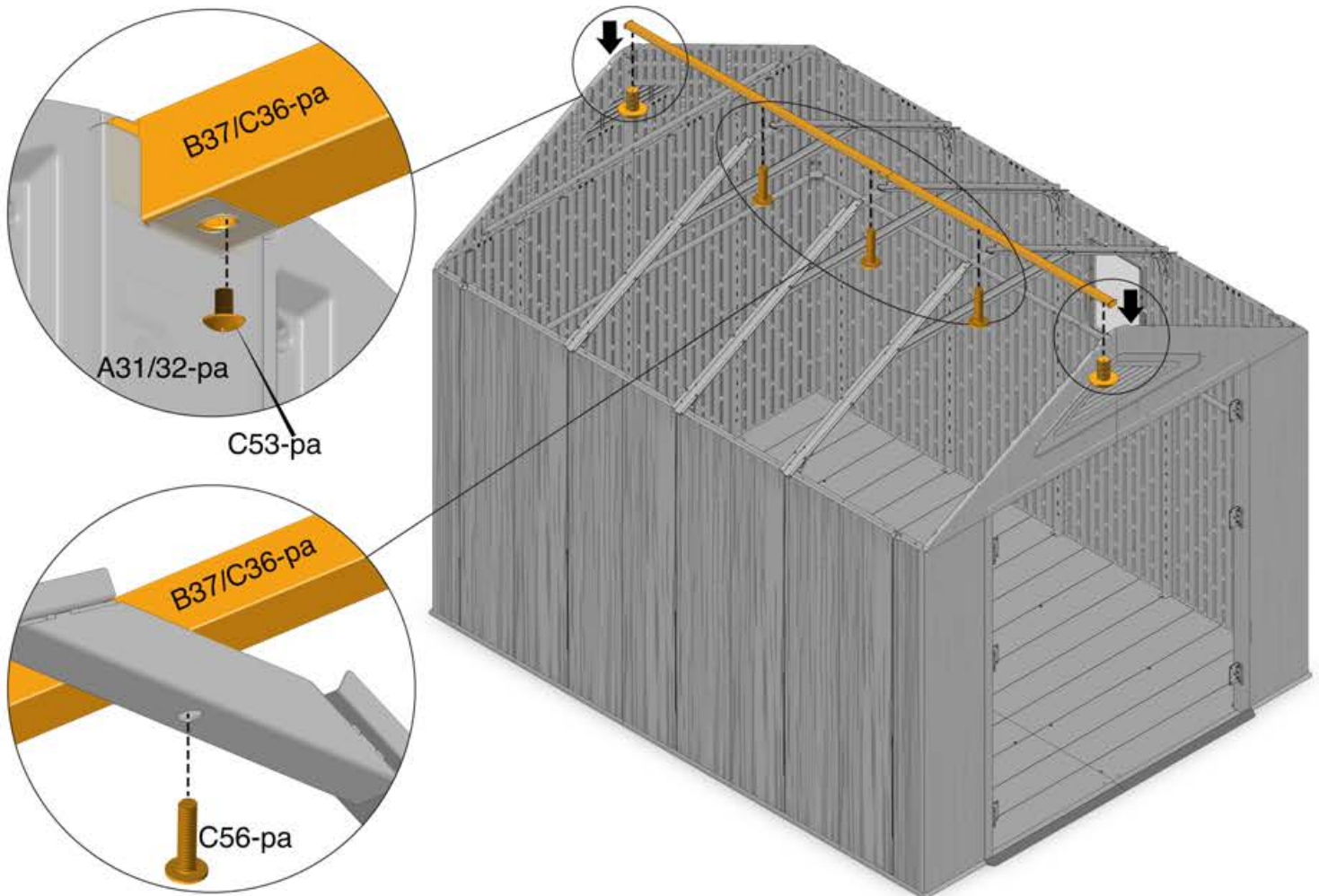
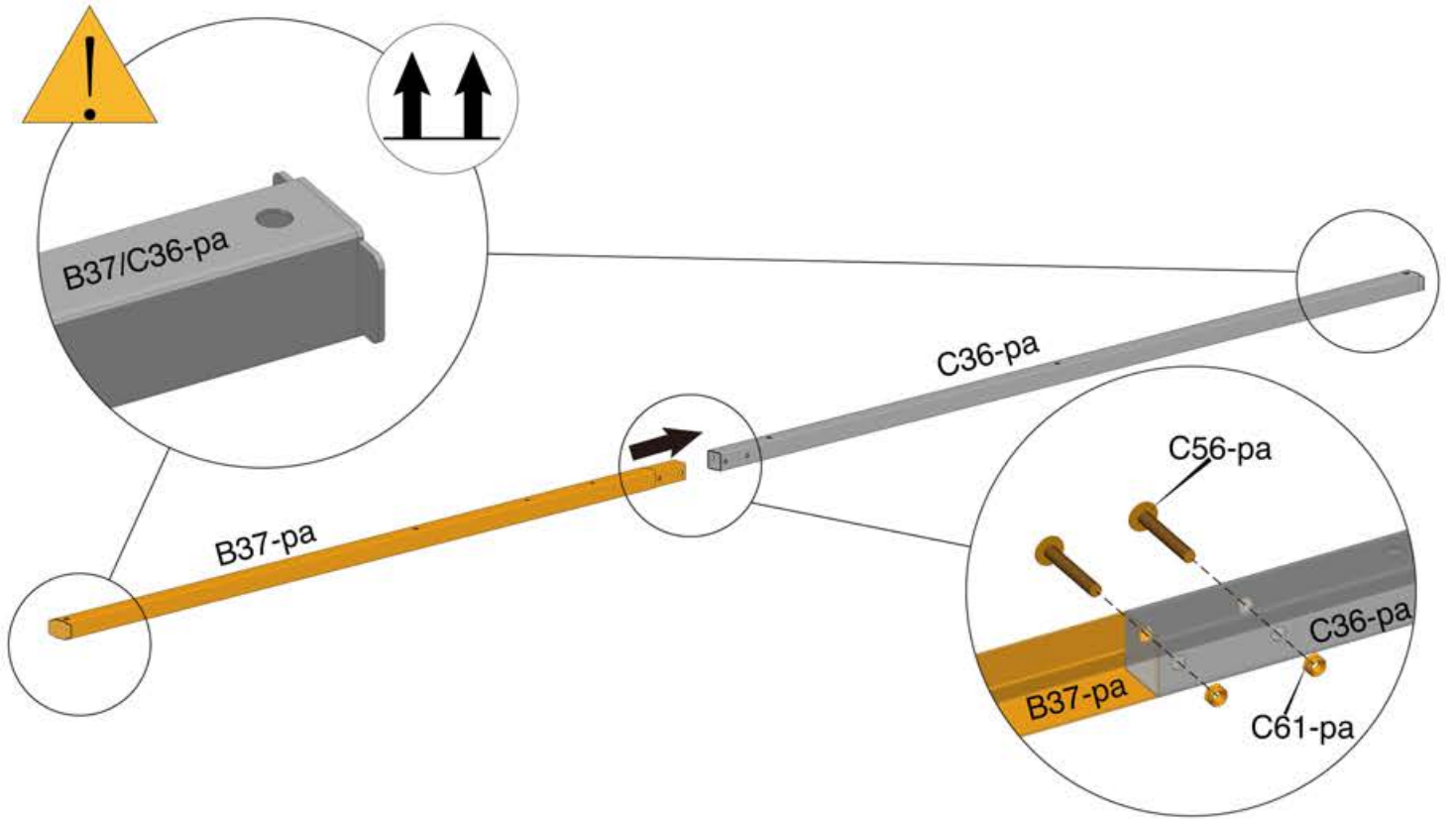
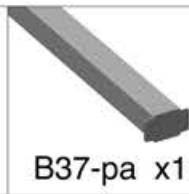
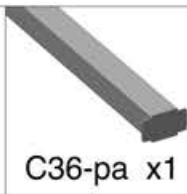

25



A16-pa x2



A17-pa x2



A18-pa x4



A44-pa x4



A45-pa x4



C51-pa x16

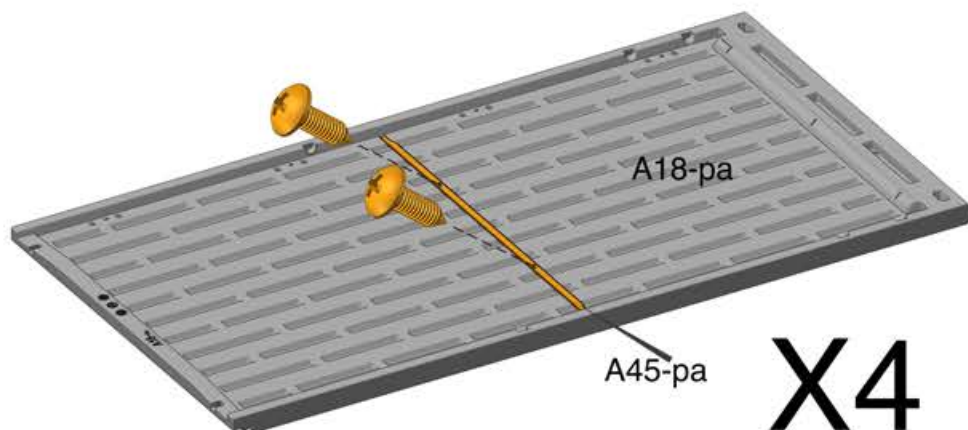
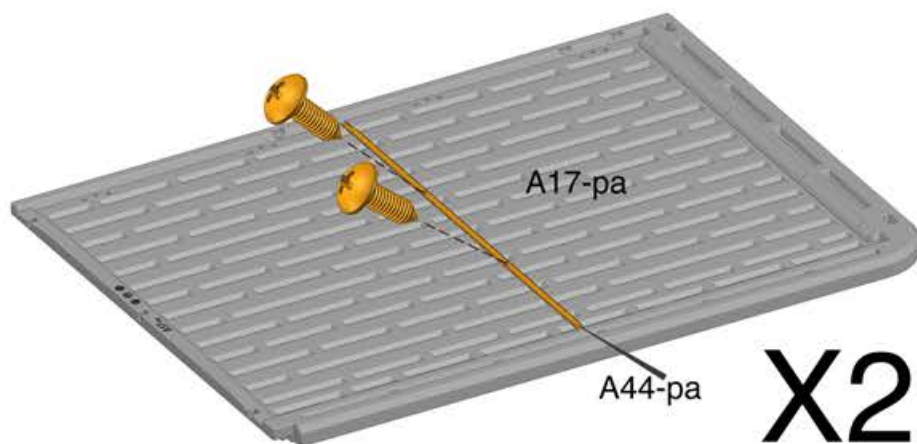
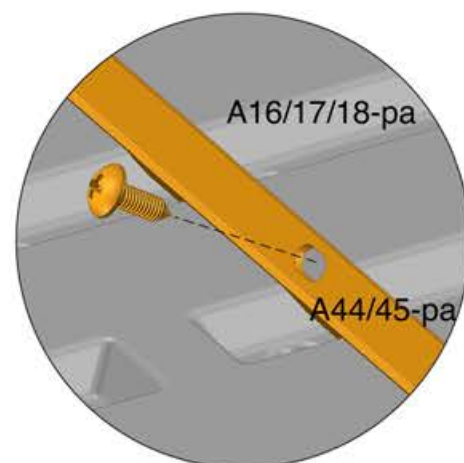
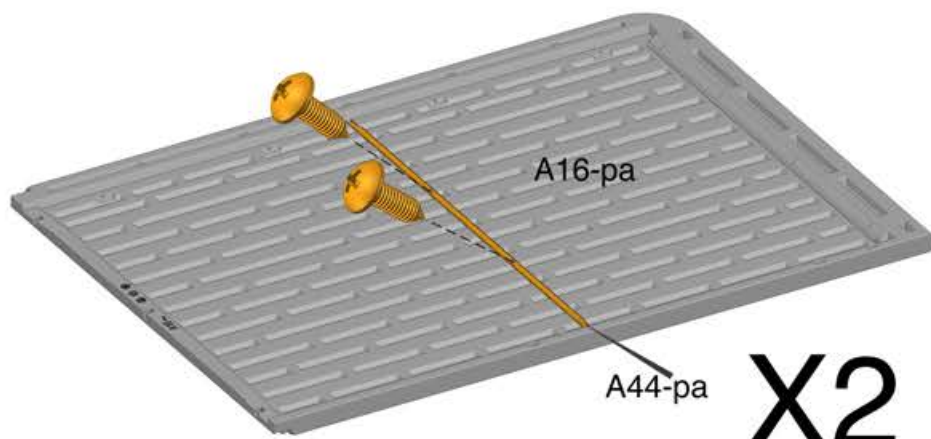
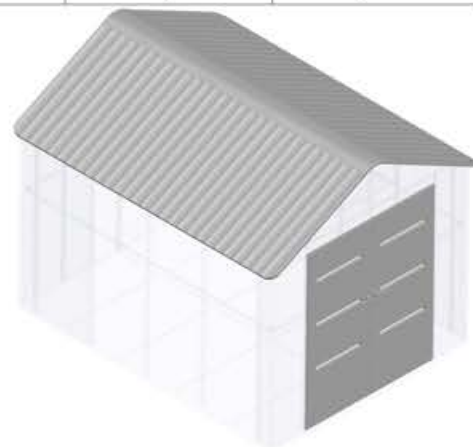

26



C59-pa x16



C58-pa x8

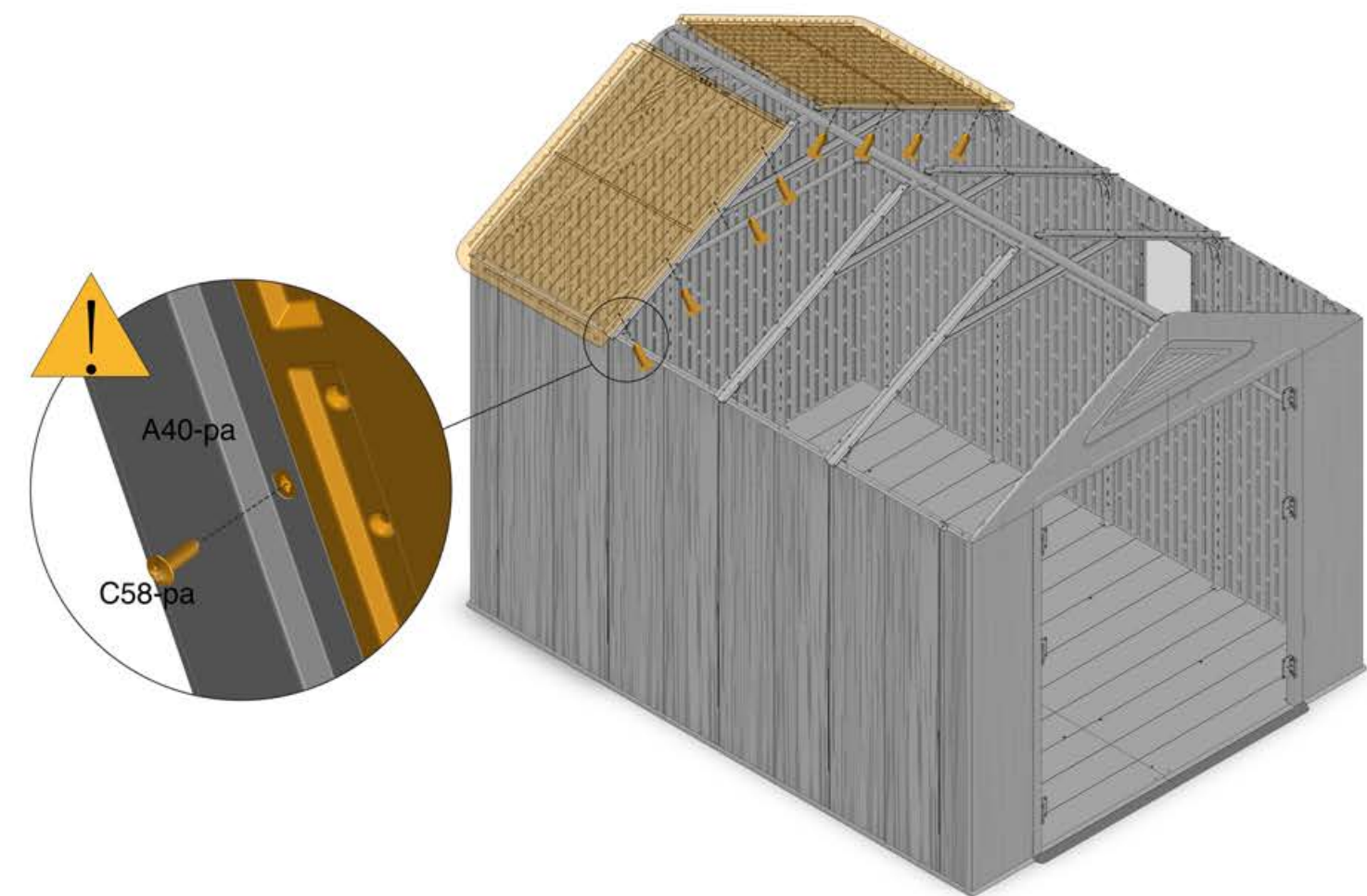
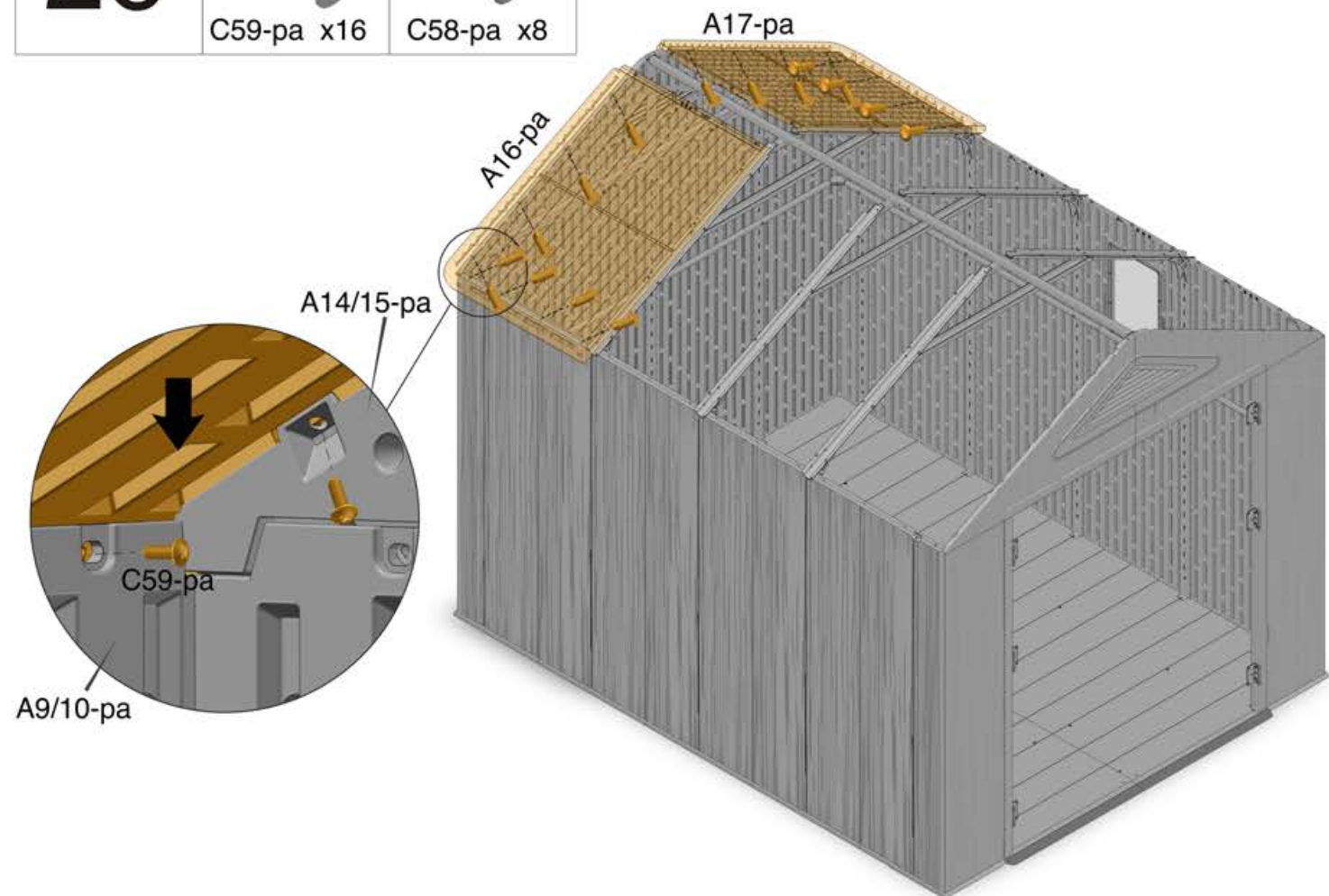

27



A19-pa x1



C59-pa x12

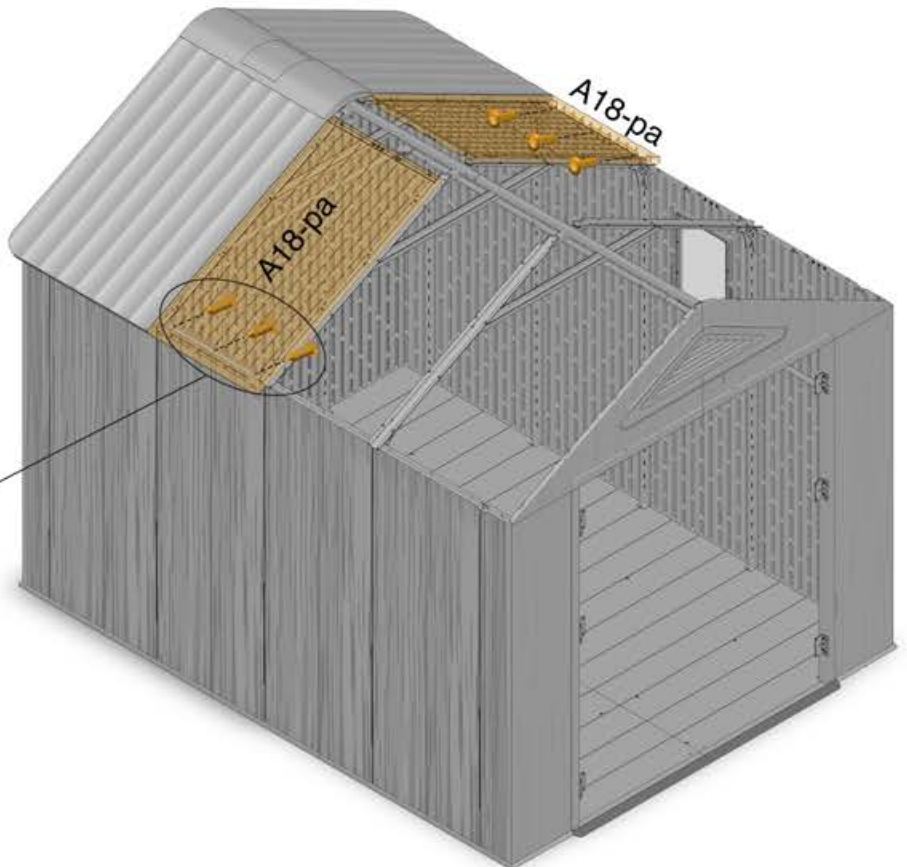
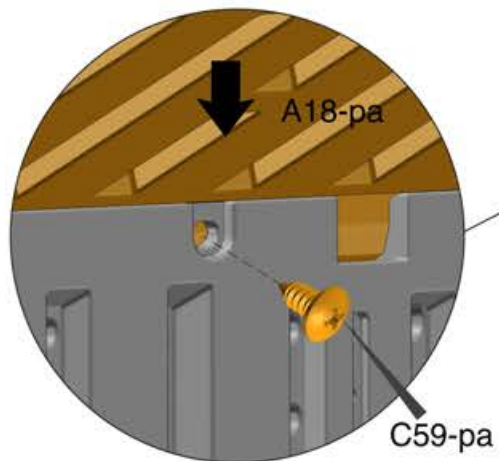
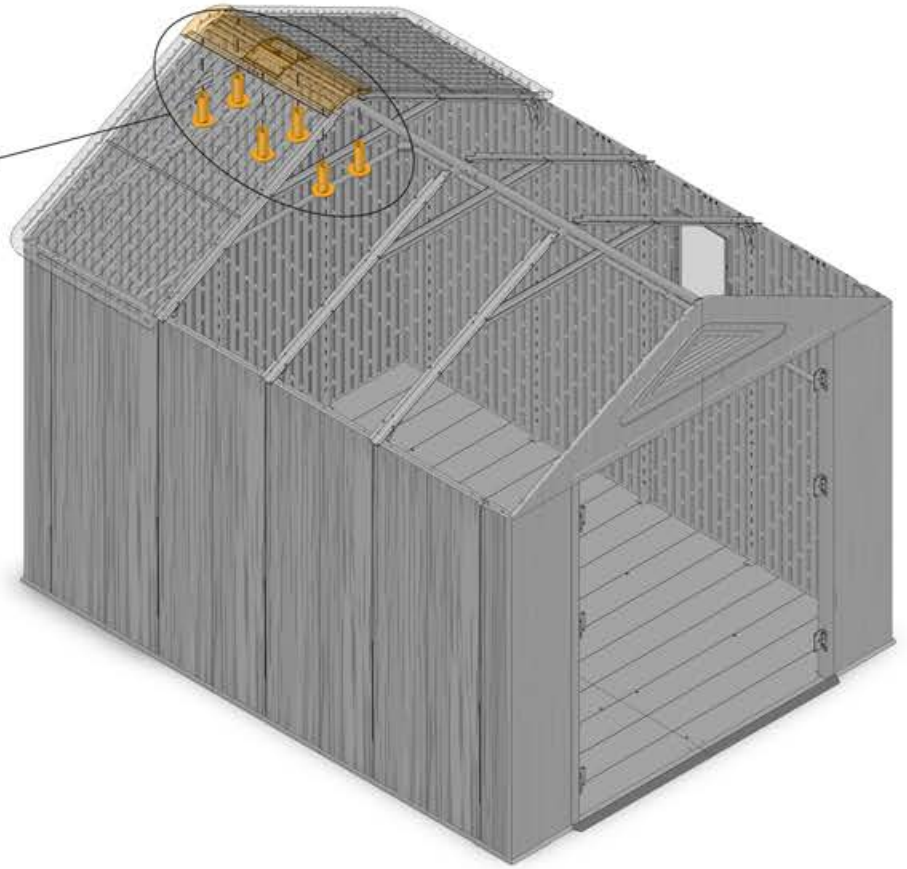
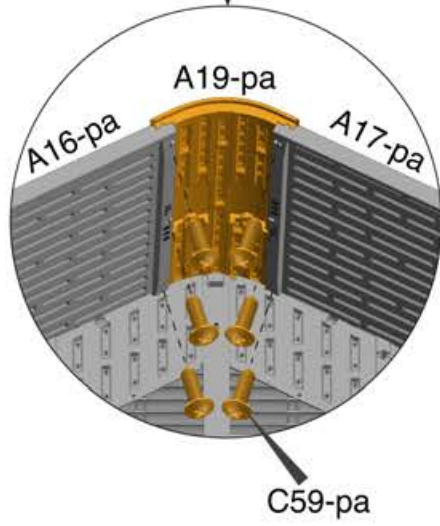
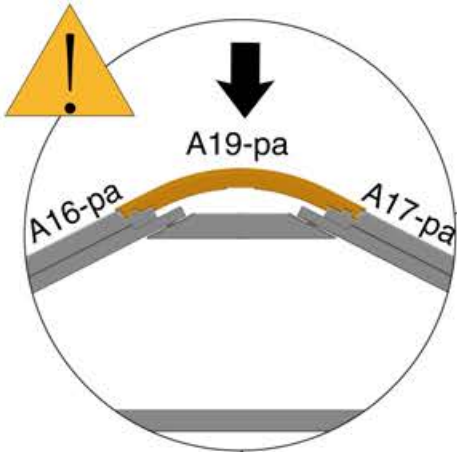

28



A21-pa x1



C58-pa x16



C59-pa x4

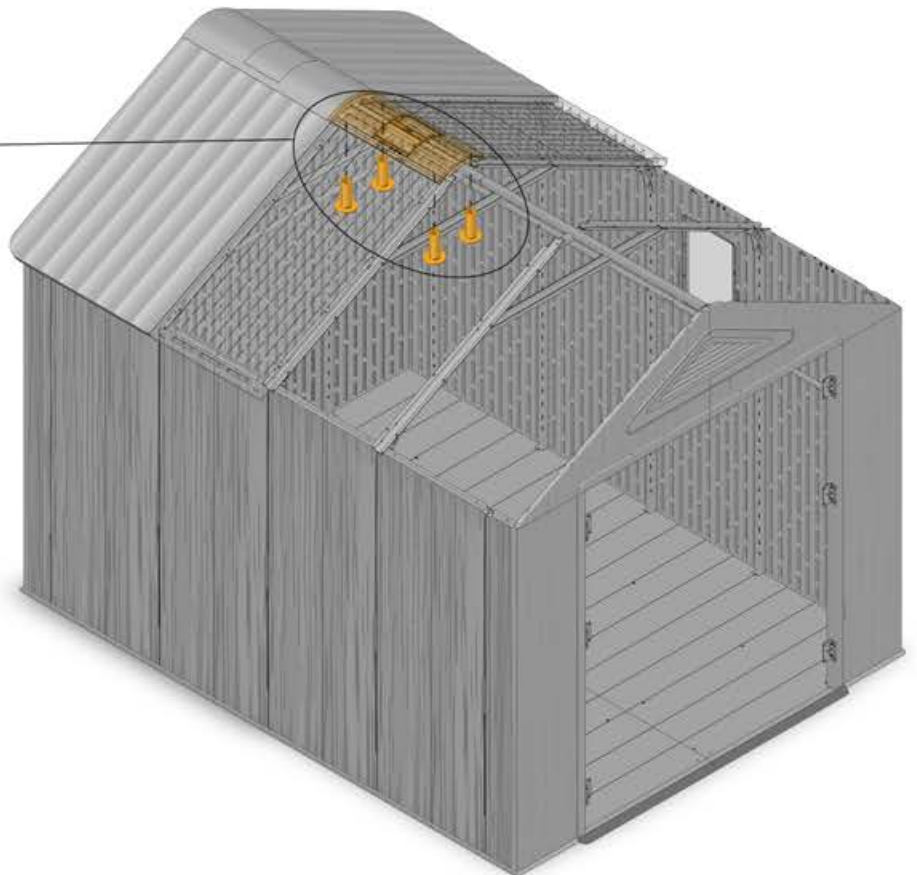
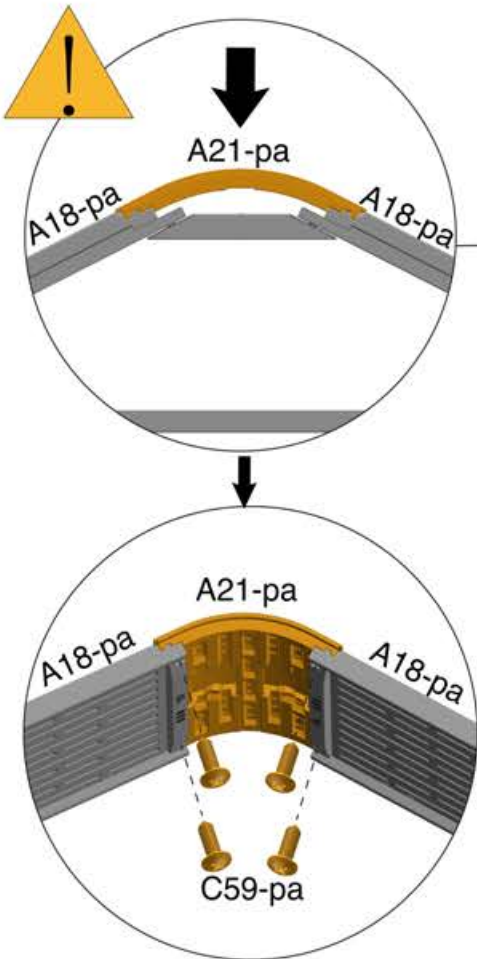
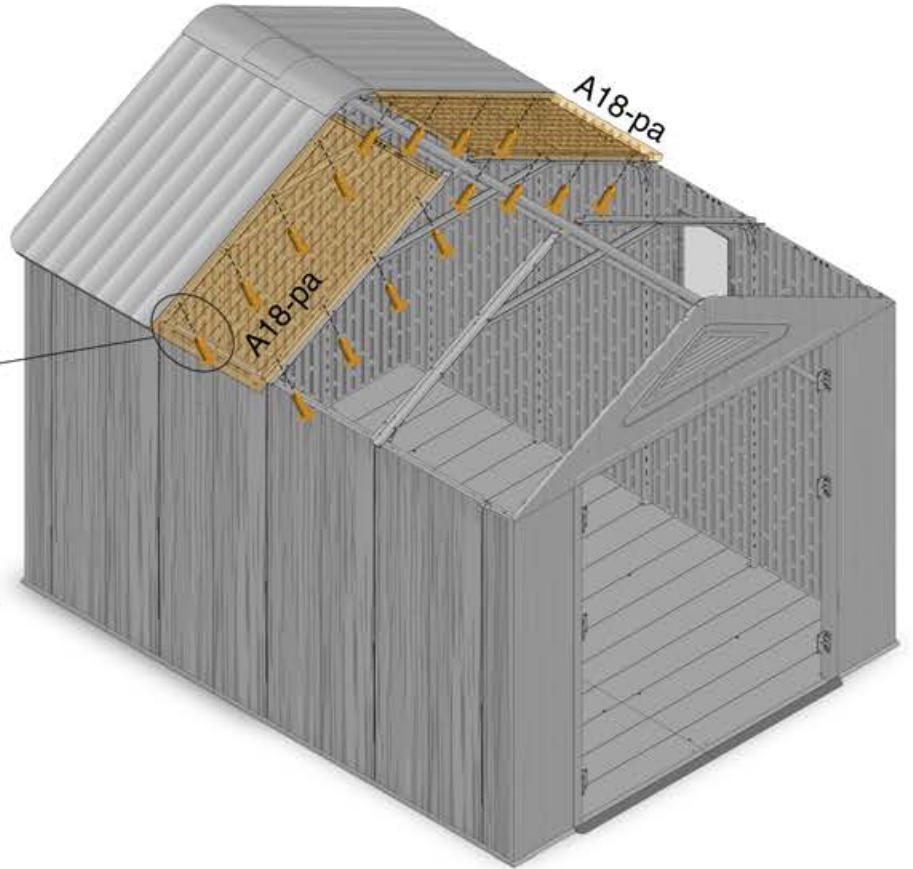
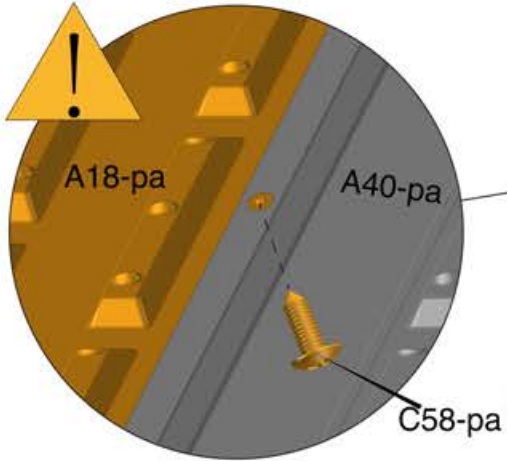

29



C59-pa x6



C58-pa x16

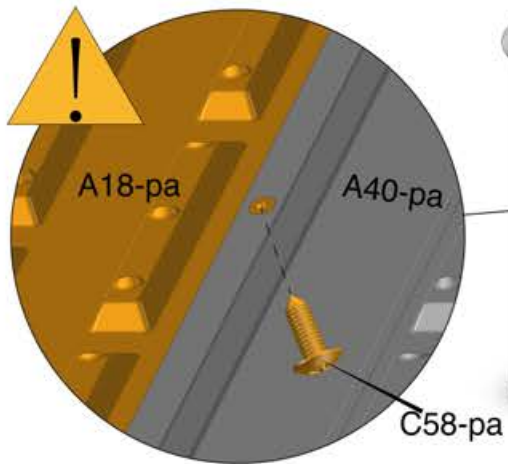
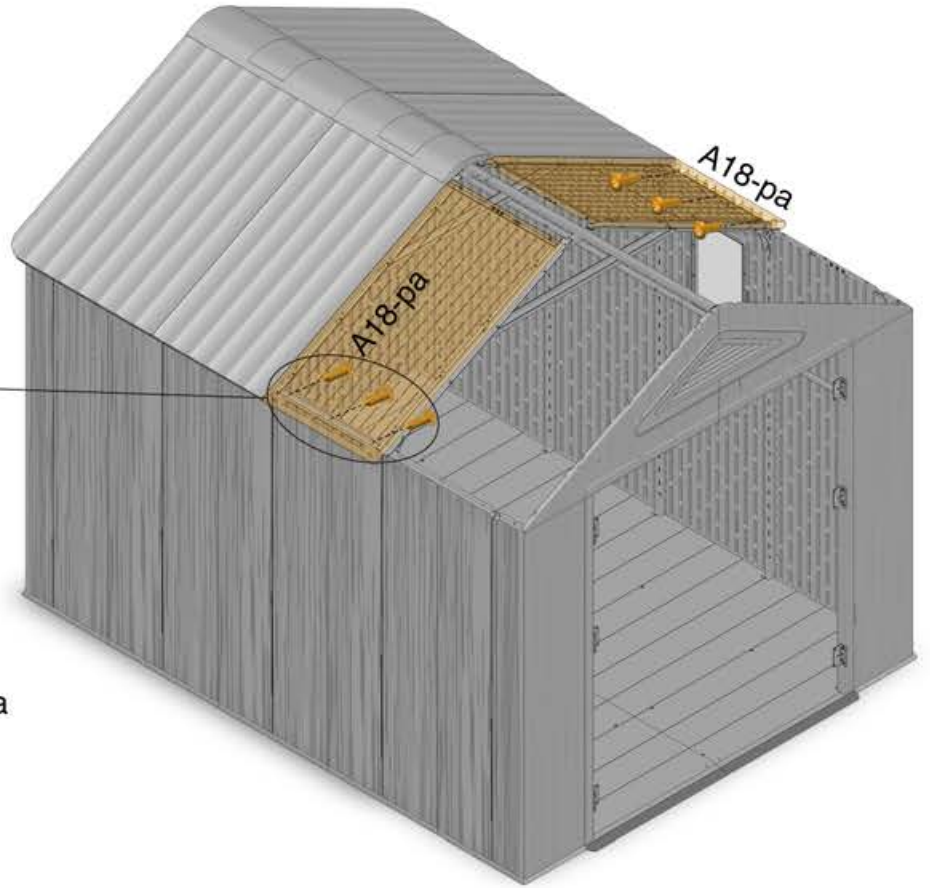
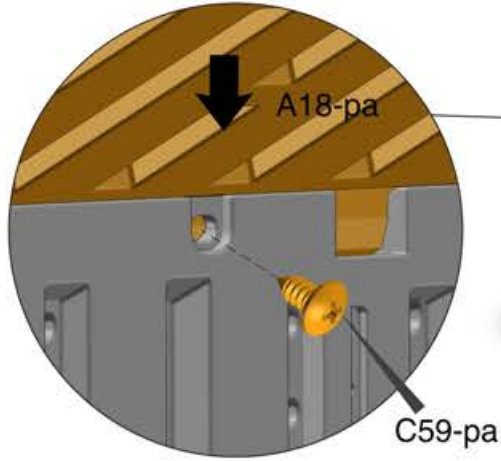

30



A21-pa x1



C59-pa x20

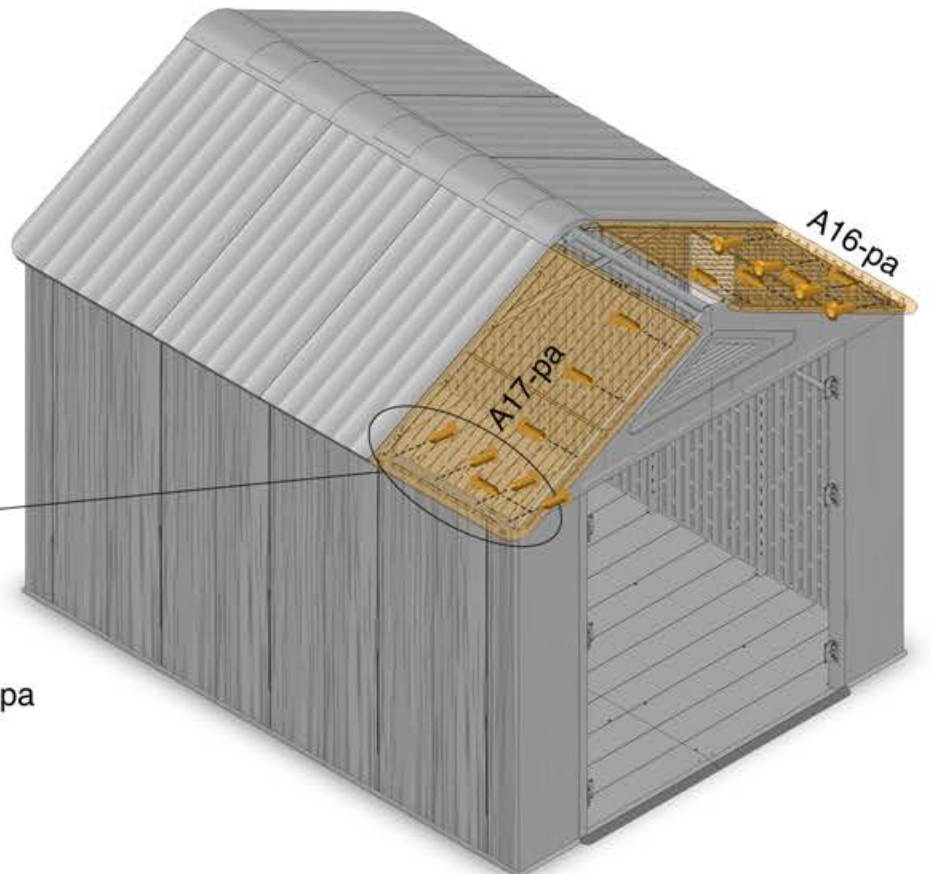
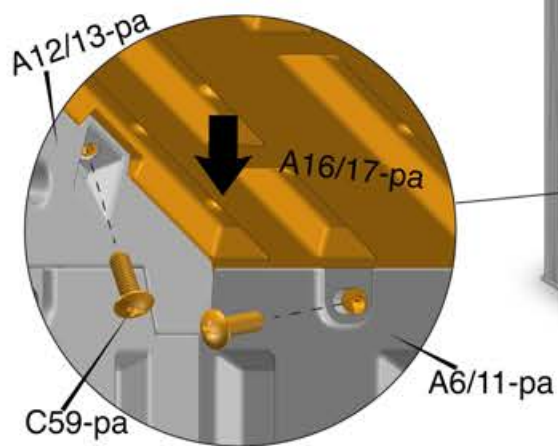
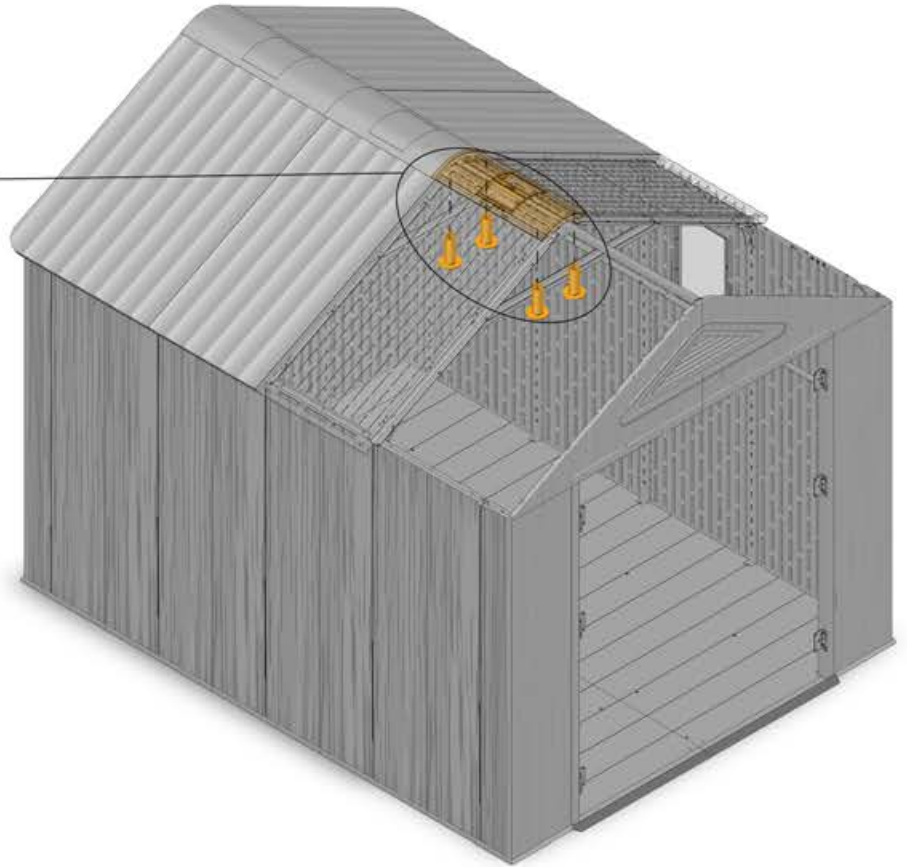
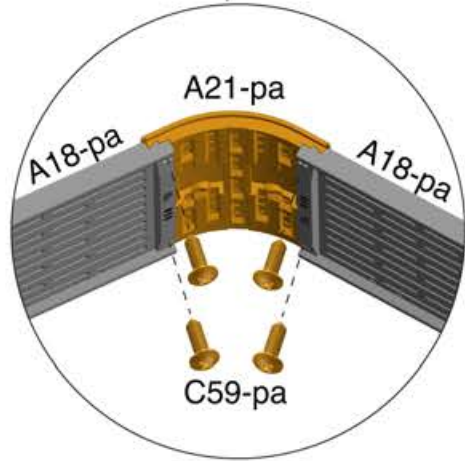
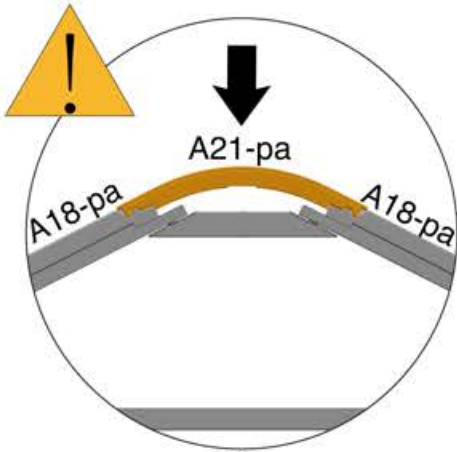

31



A20-pa x1



C58-pa x8



C59-pa x6

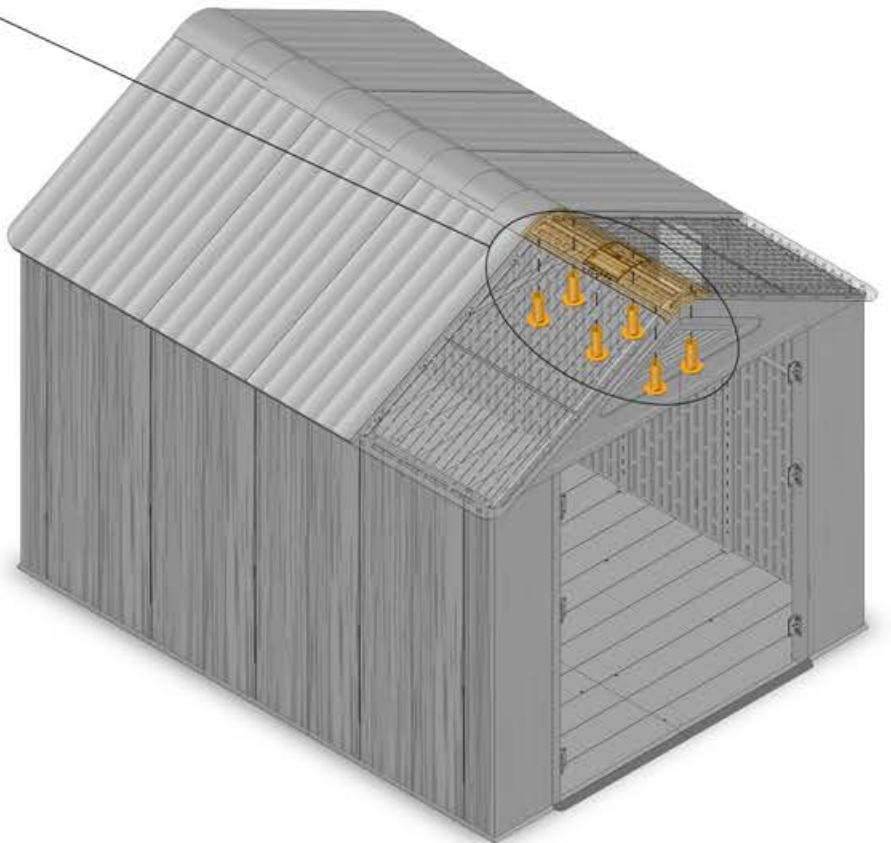
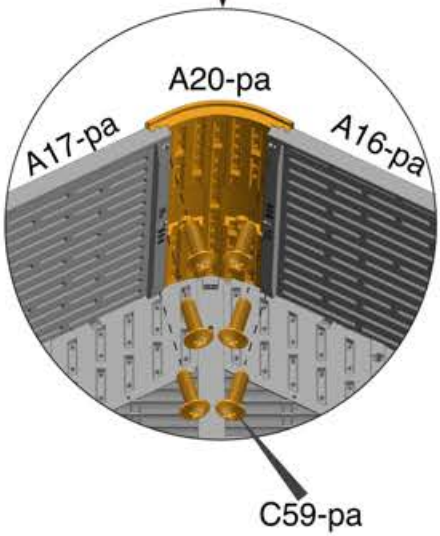
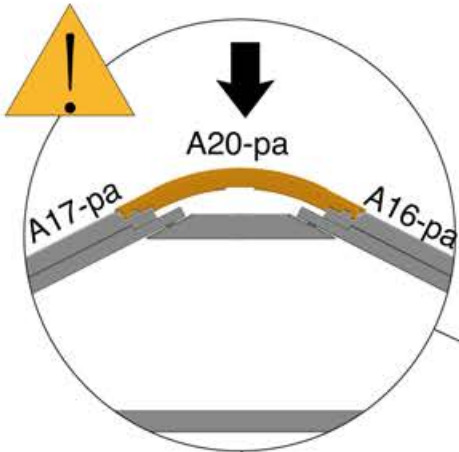
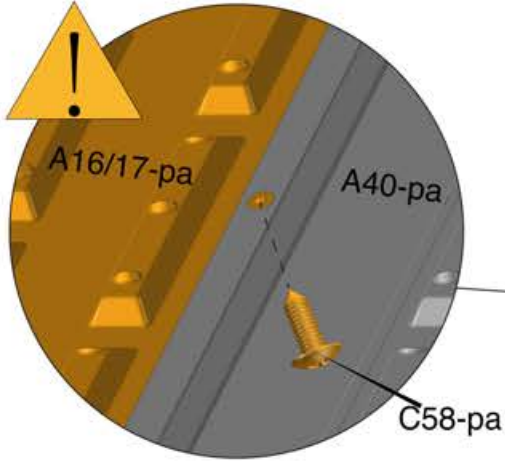

32



A22-pa x1



A23-pa x1



A34-pa x2



A34a-pa x2



C57-pa x20

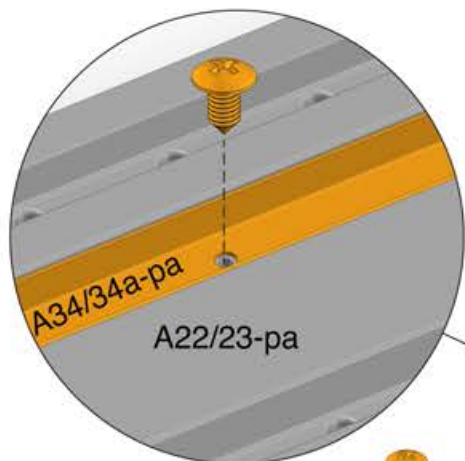

A22/23-pa

A34/34a-pa

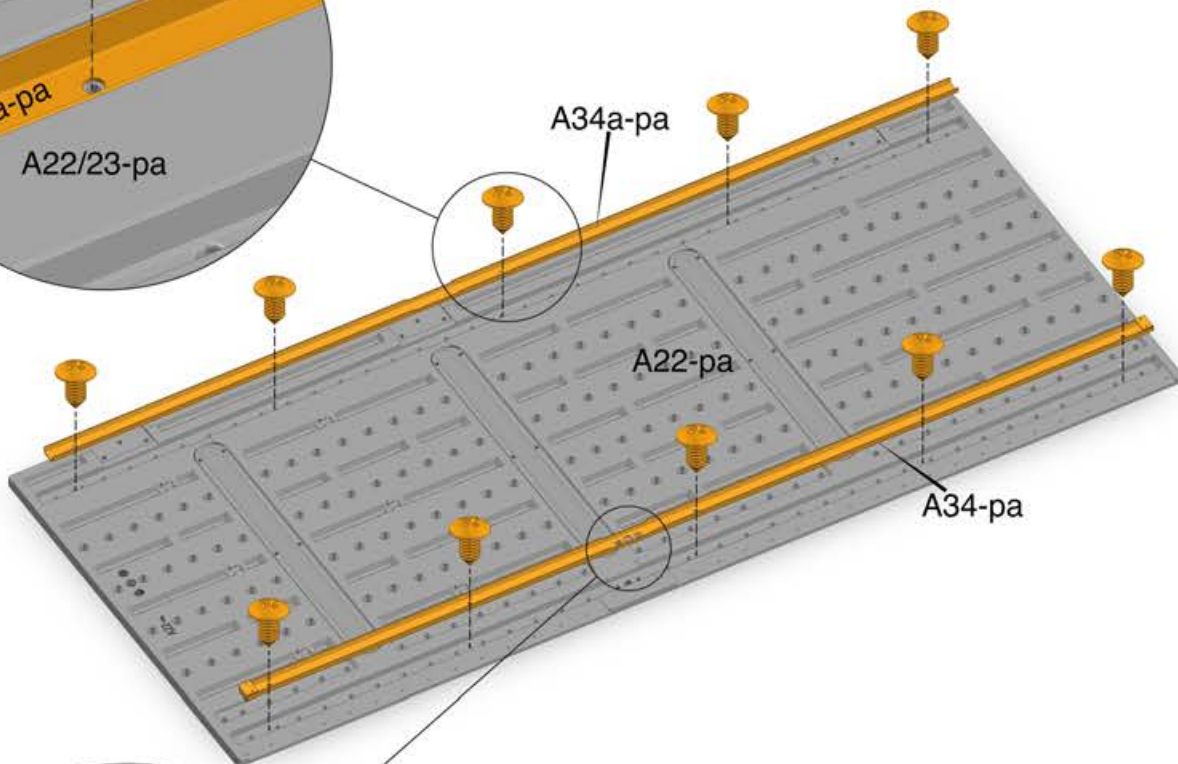

A34a-pa

A22-pa

A34-pa

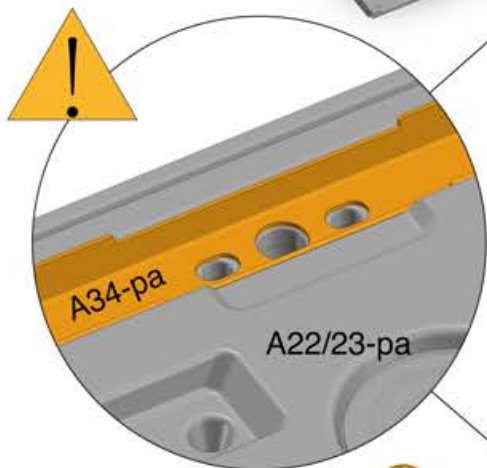

A34-pa

A22/23-pa

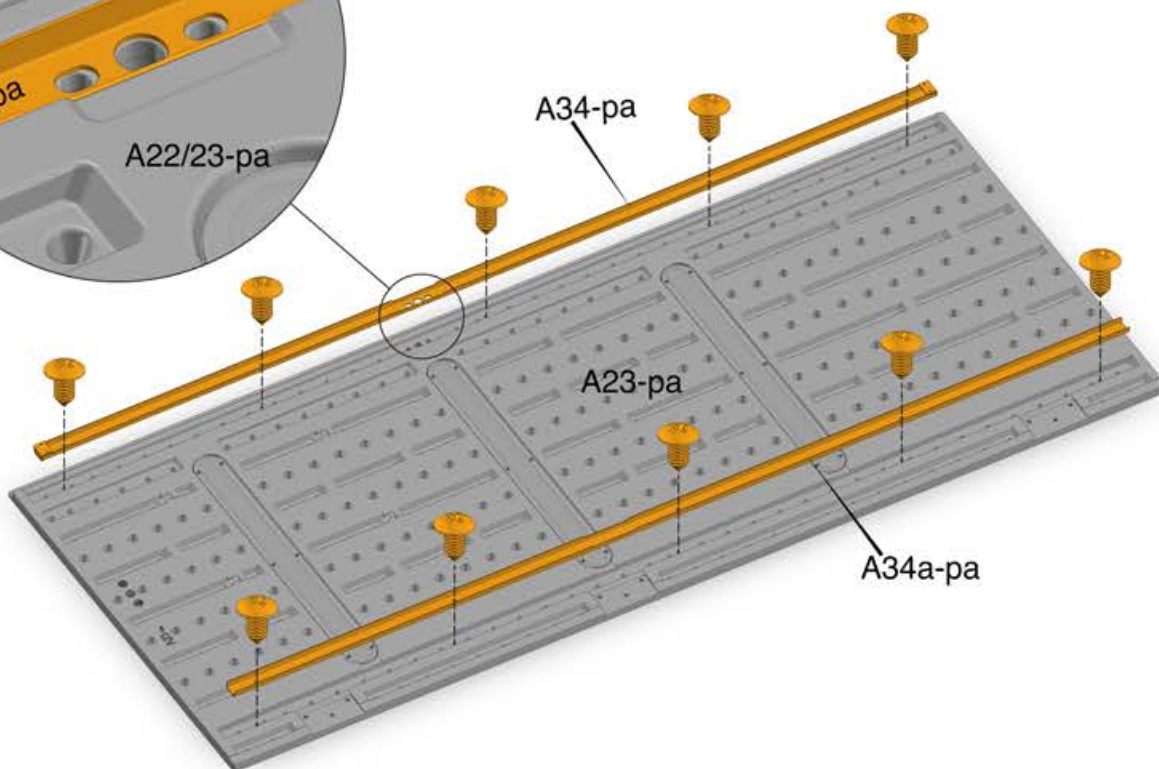

A34-pa

A23-pa

A34a-pa

33



13-pa x2



14-pa x2



C51-pa x8

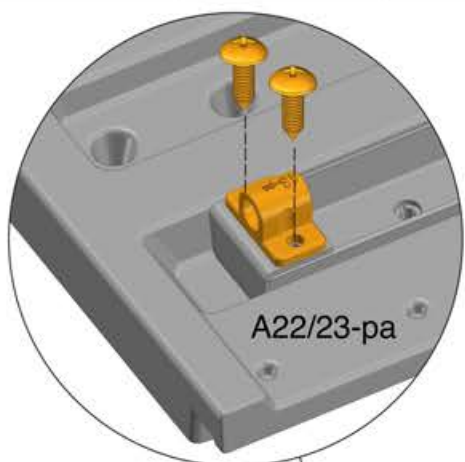

A22/23-pa

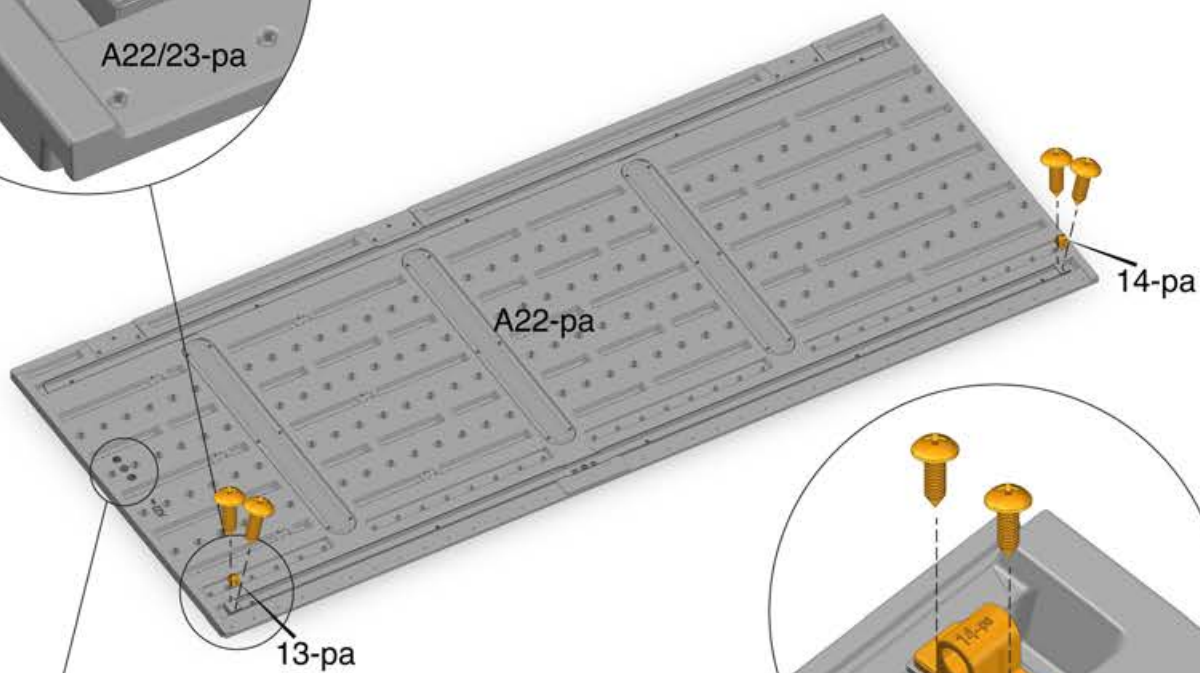

A22-pa

14-pa

13-pa

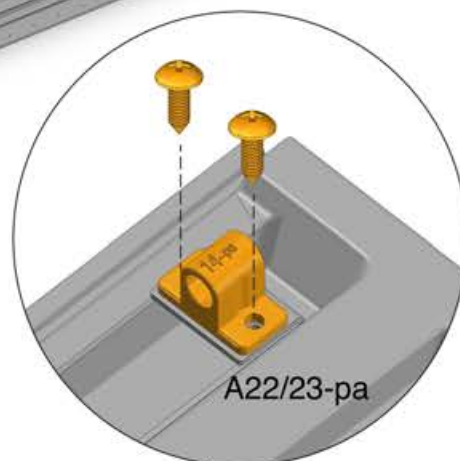

A22/23-pa

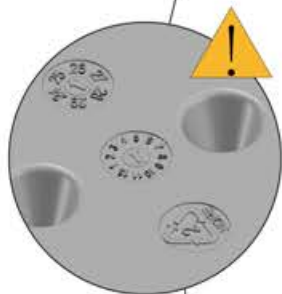

14-pa

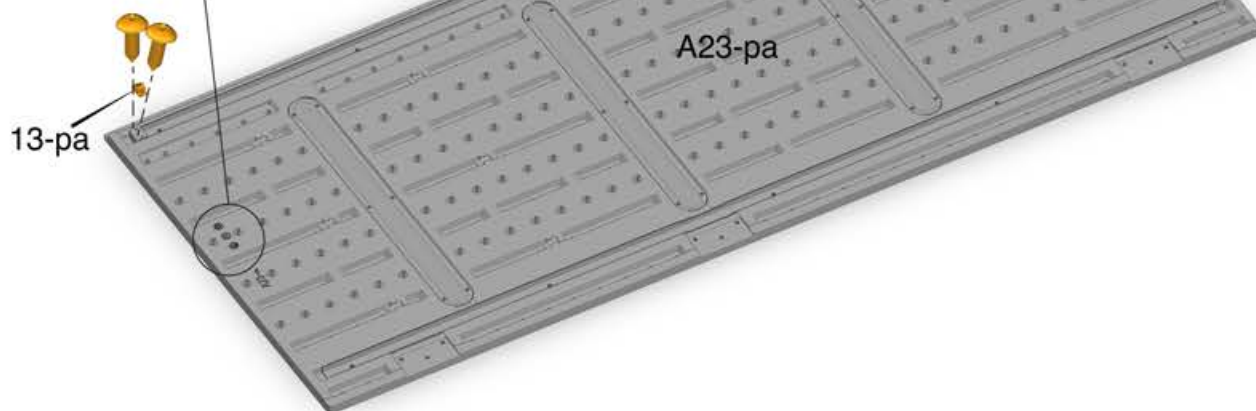

A23-pa

13-pa

34



C53-pa x9

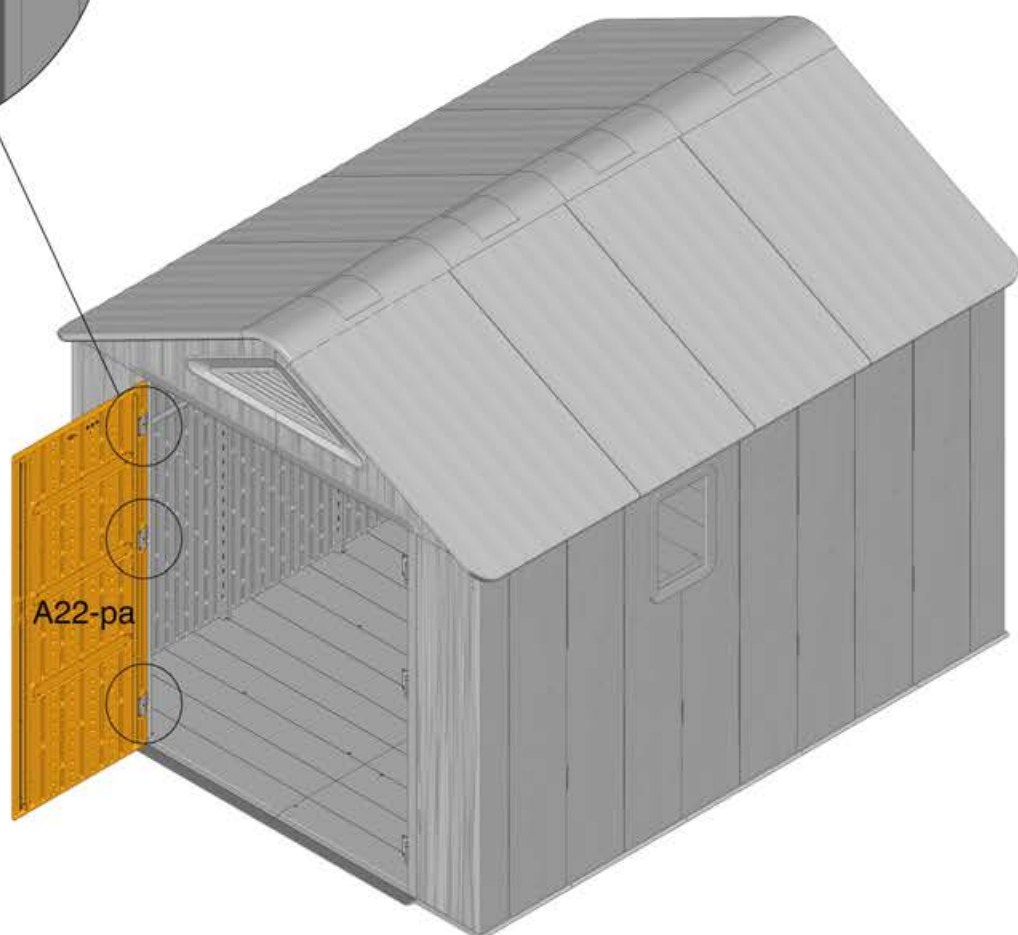
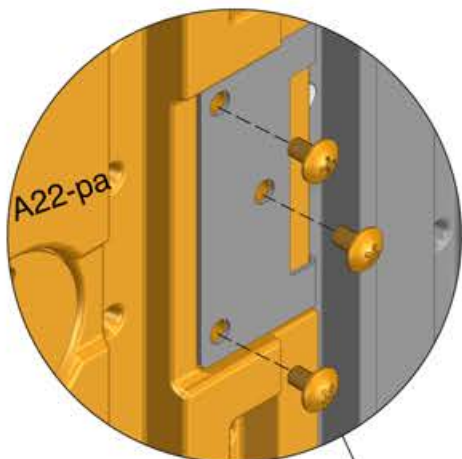

35



1-pa x1



1.1-pa x2



1.2-pa x2



1.3-pa x1



1.4-pa x1



1.5-pa x1



7-pa x1

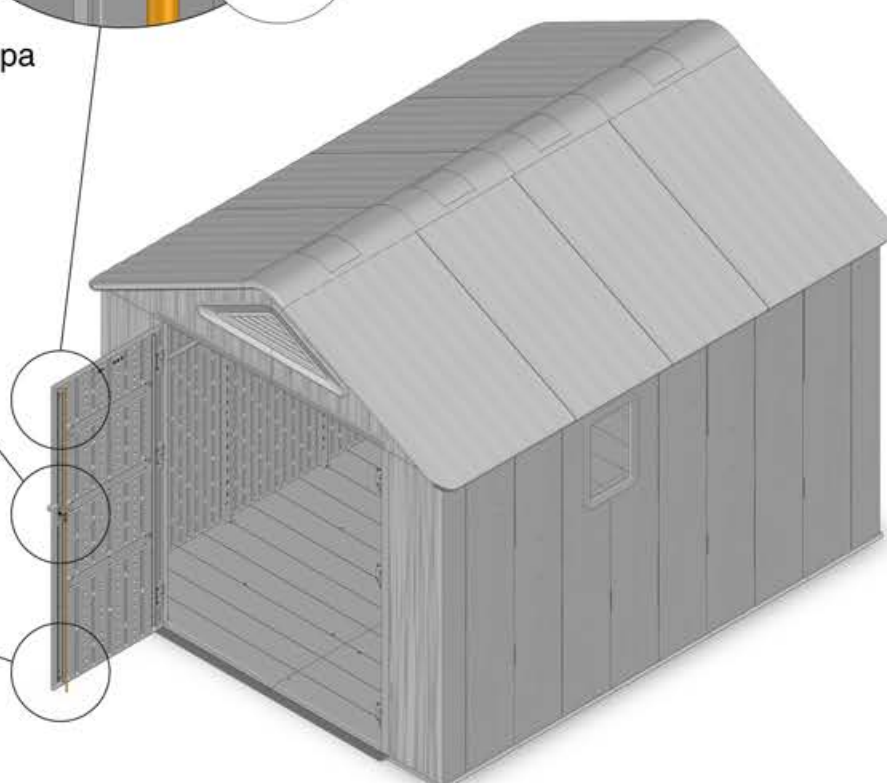
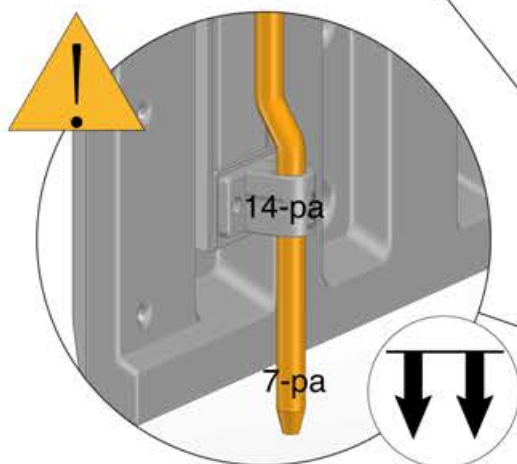
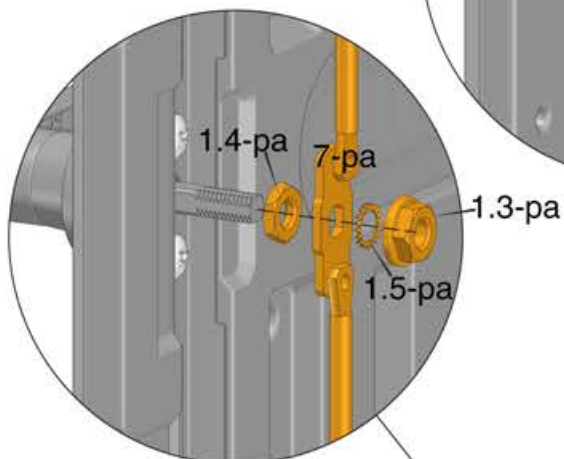
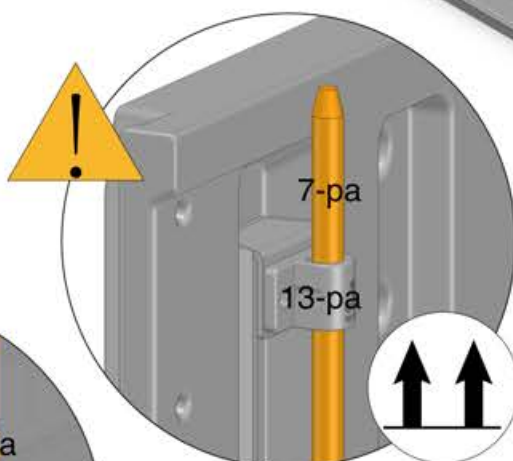
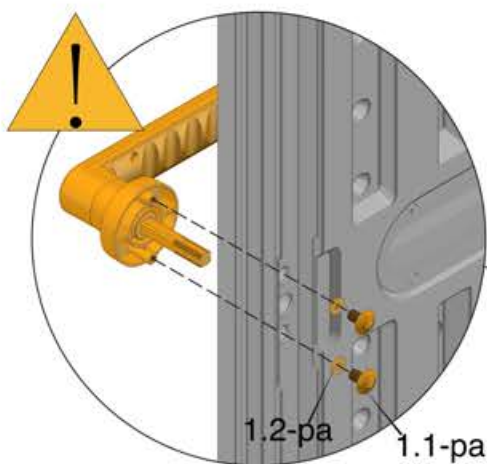
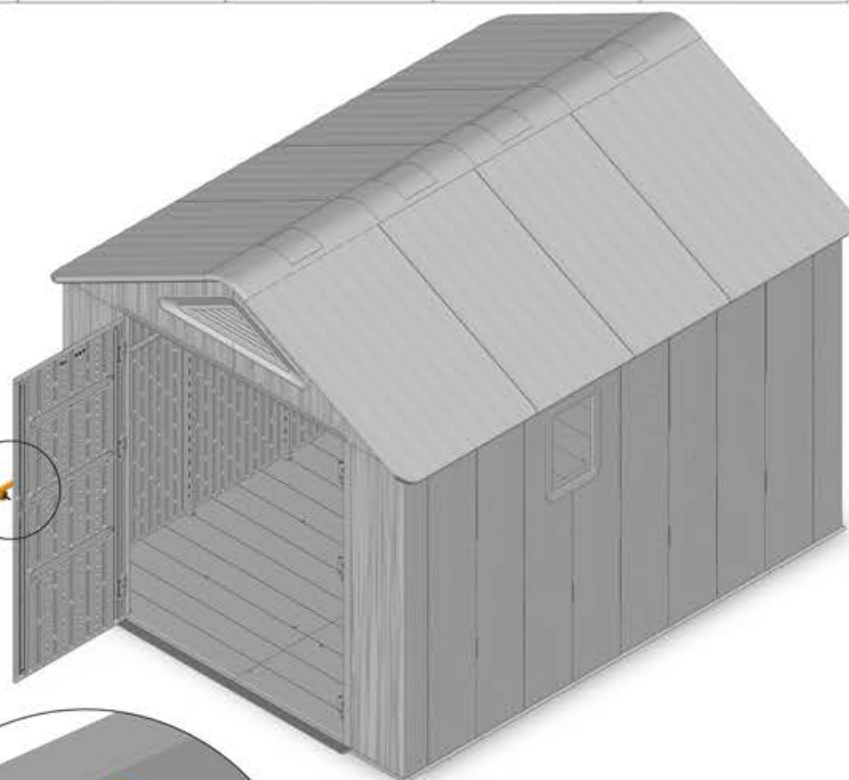

36

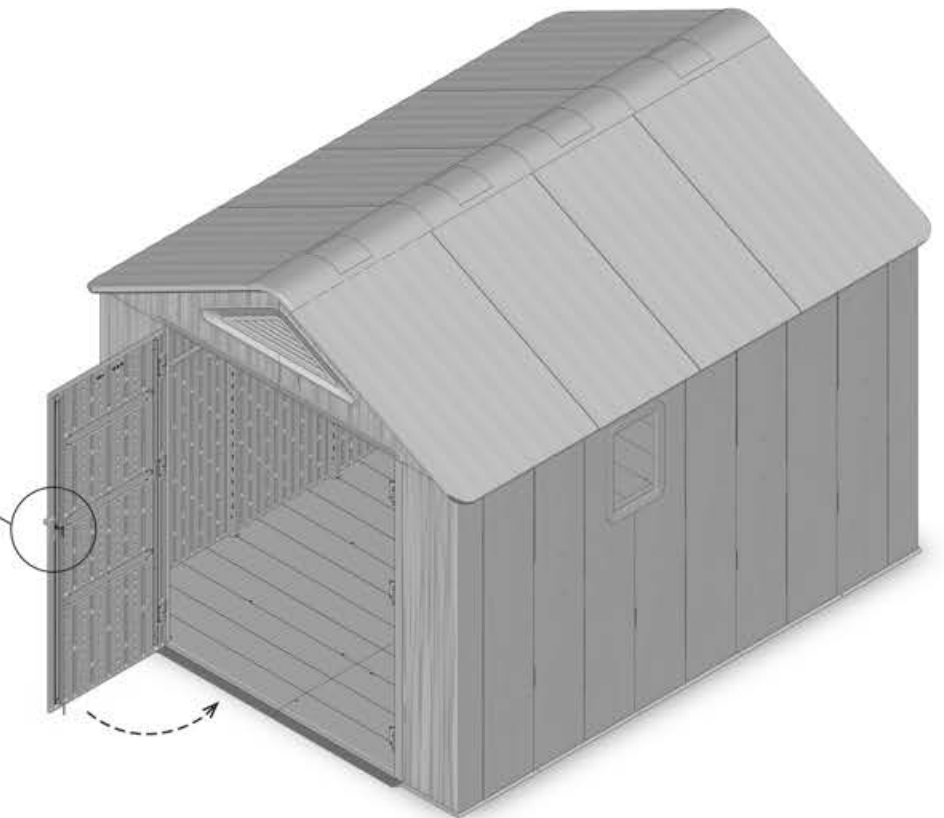
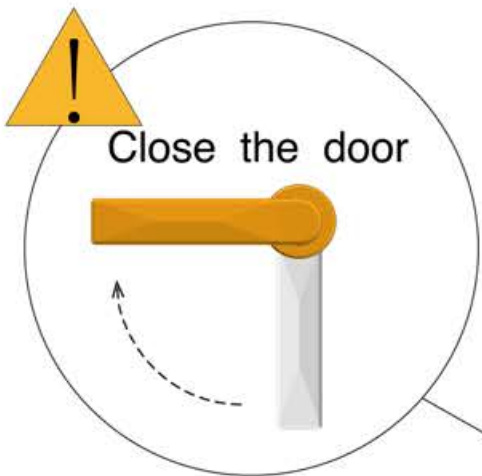
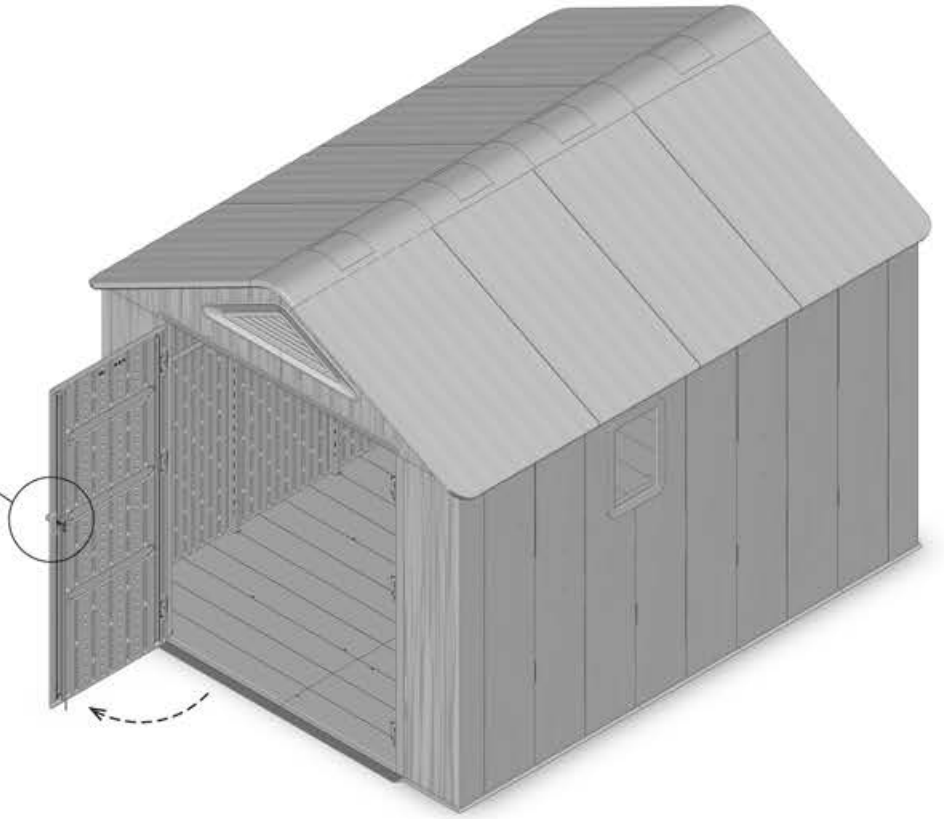
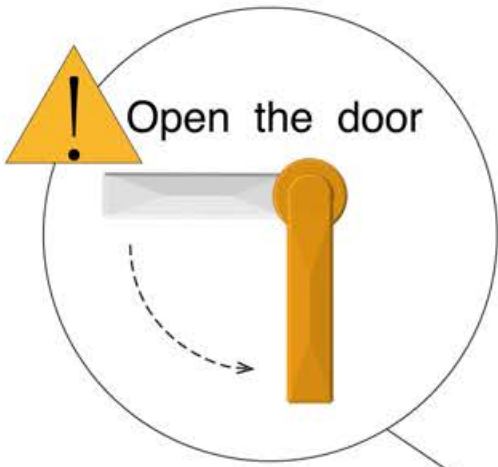

37



C53-pa x9

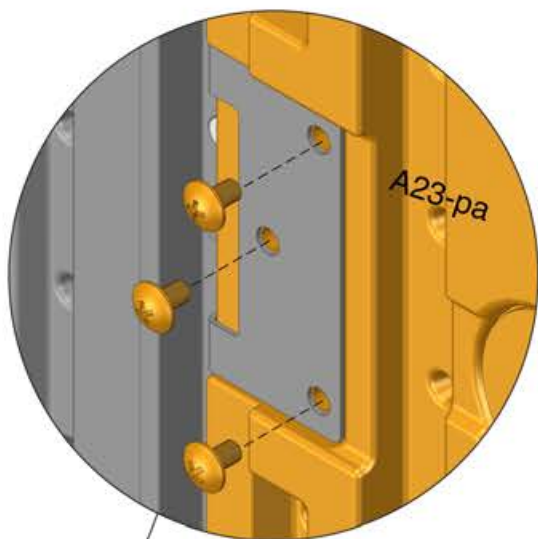
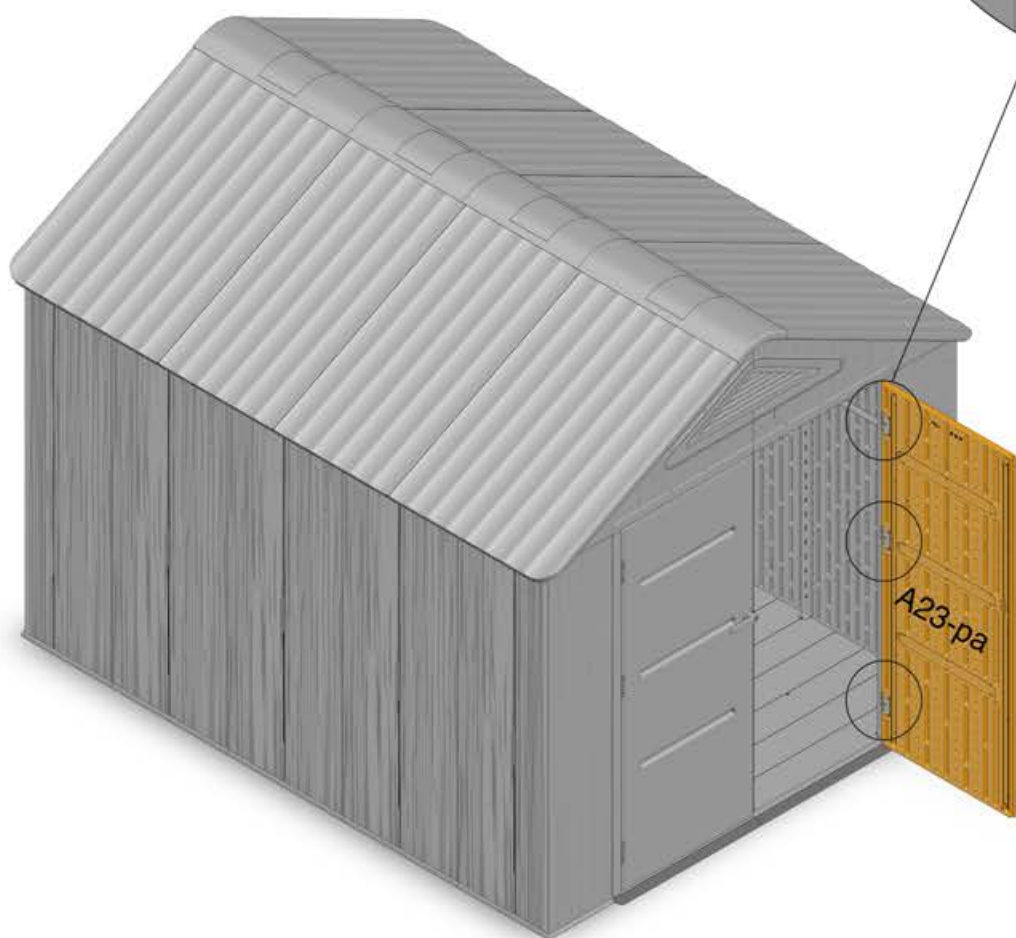

38



2-pa x1



1.1-pa x2



1.2-pa x2



1.3-pa x1



1.4-pa x1



1.5-pa x1



8-pa x1

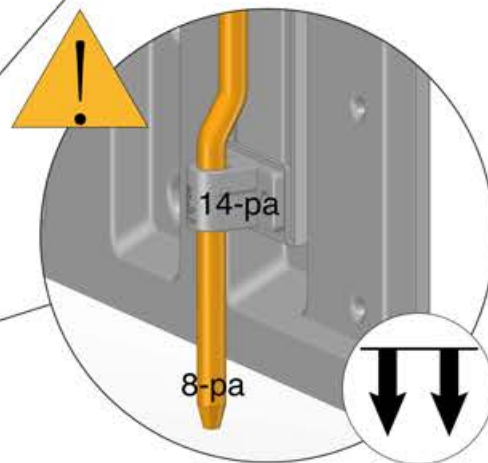
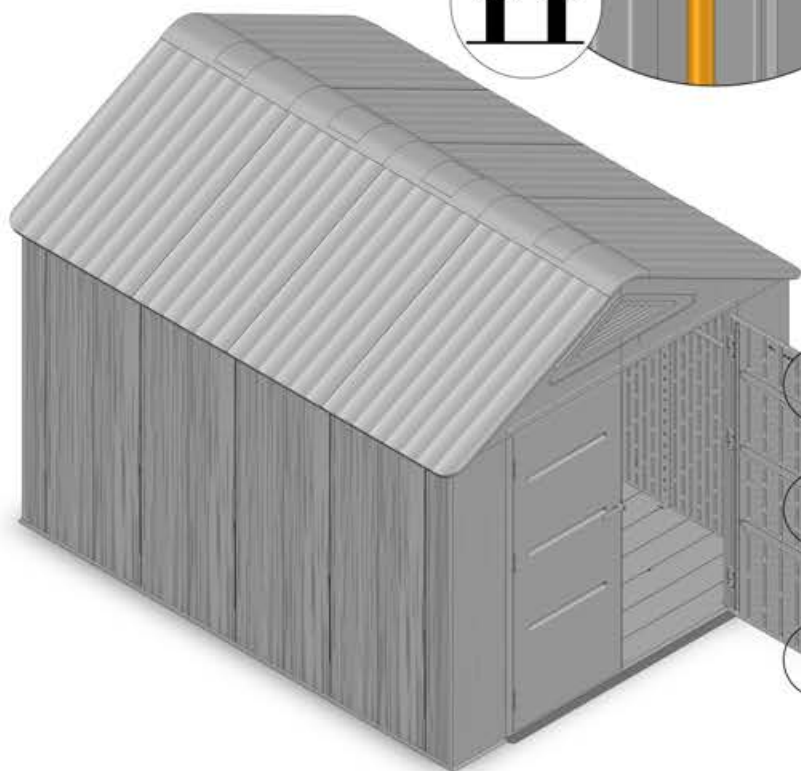
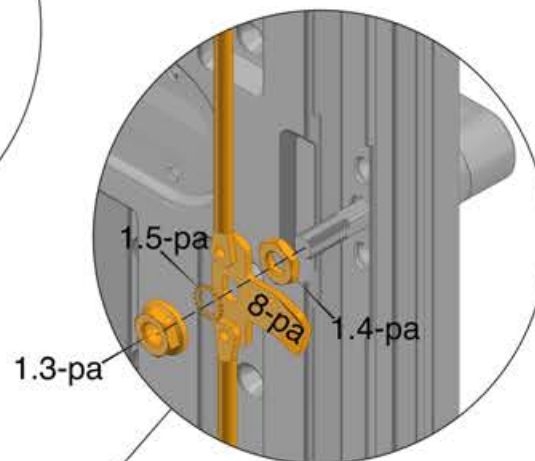
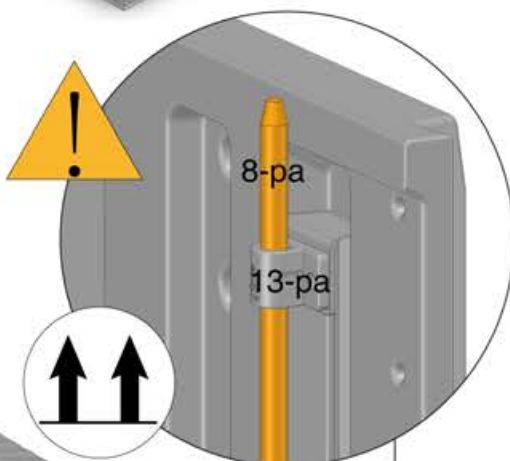
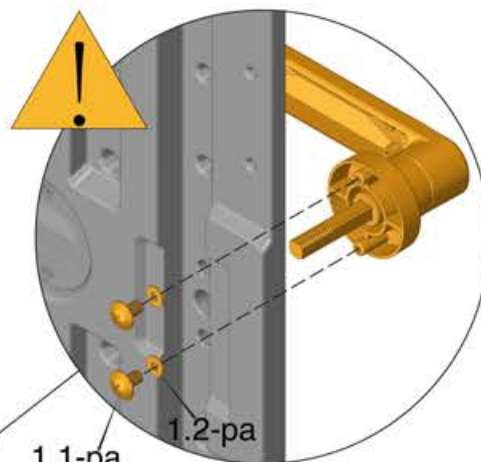
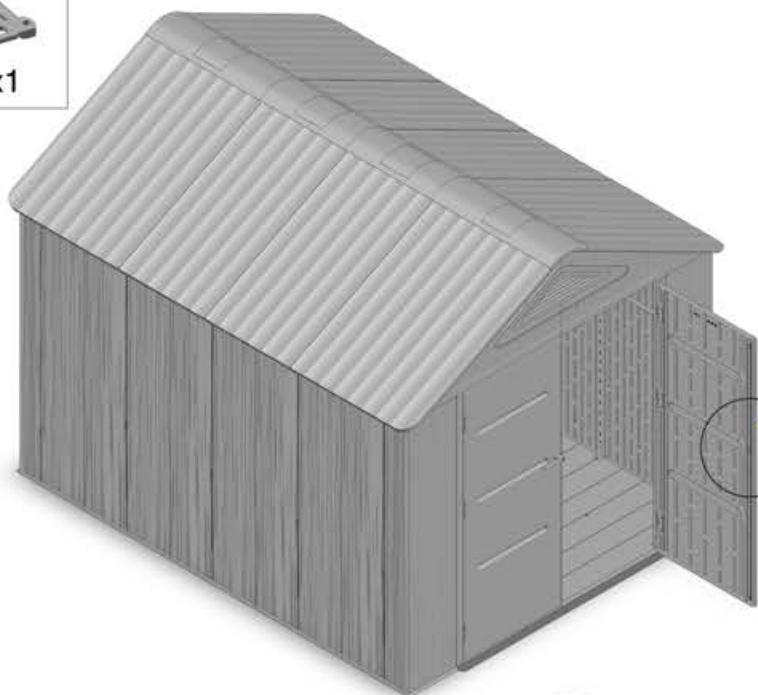

39

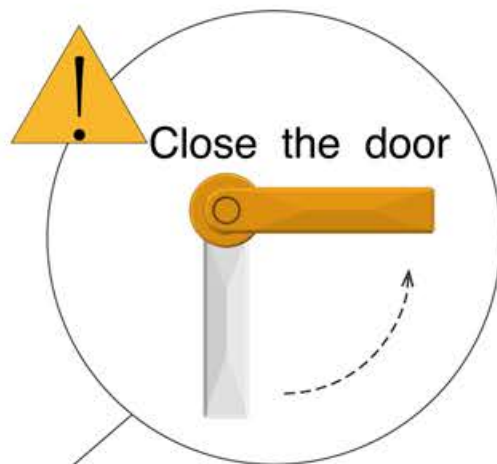
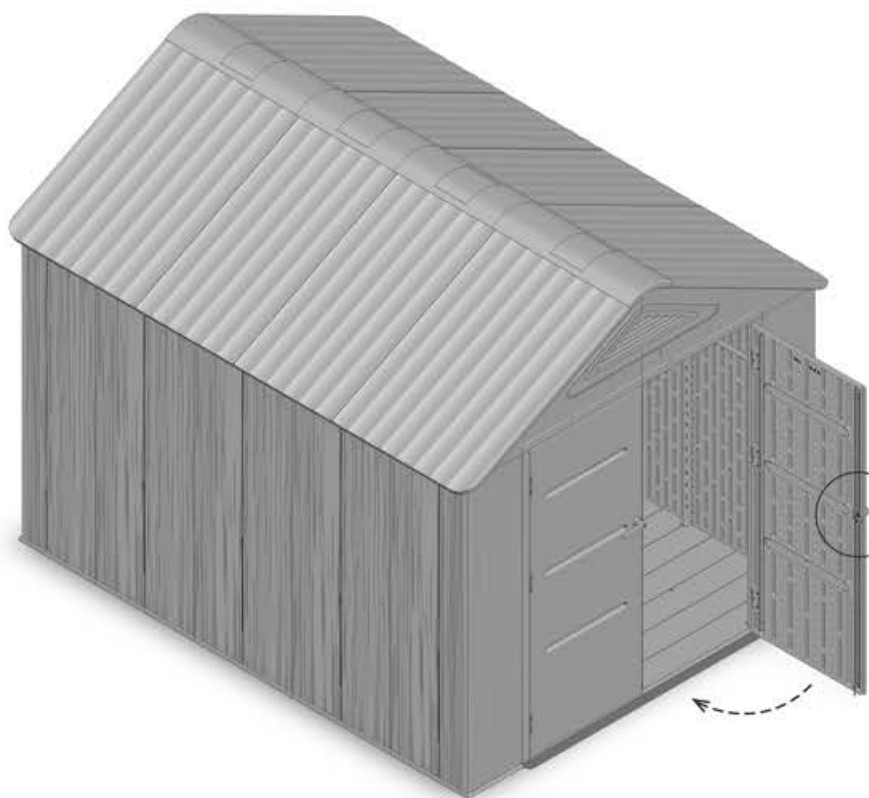
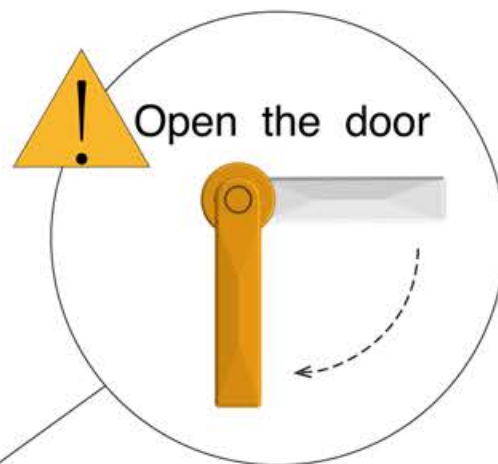
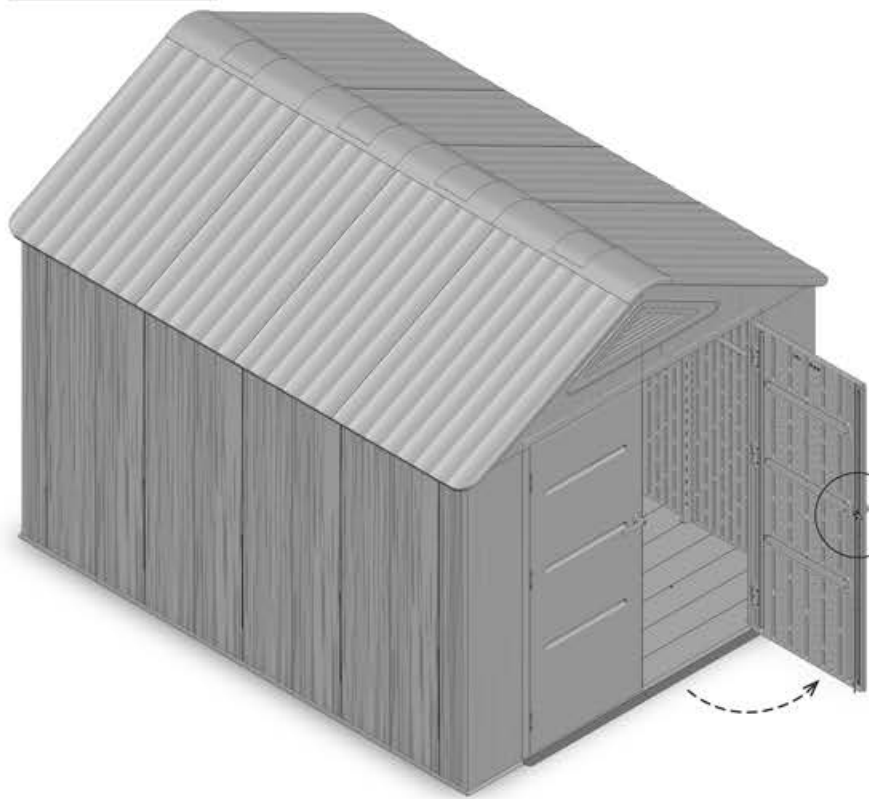

40



11-pa x5

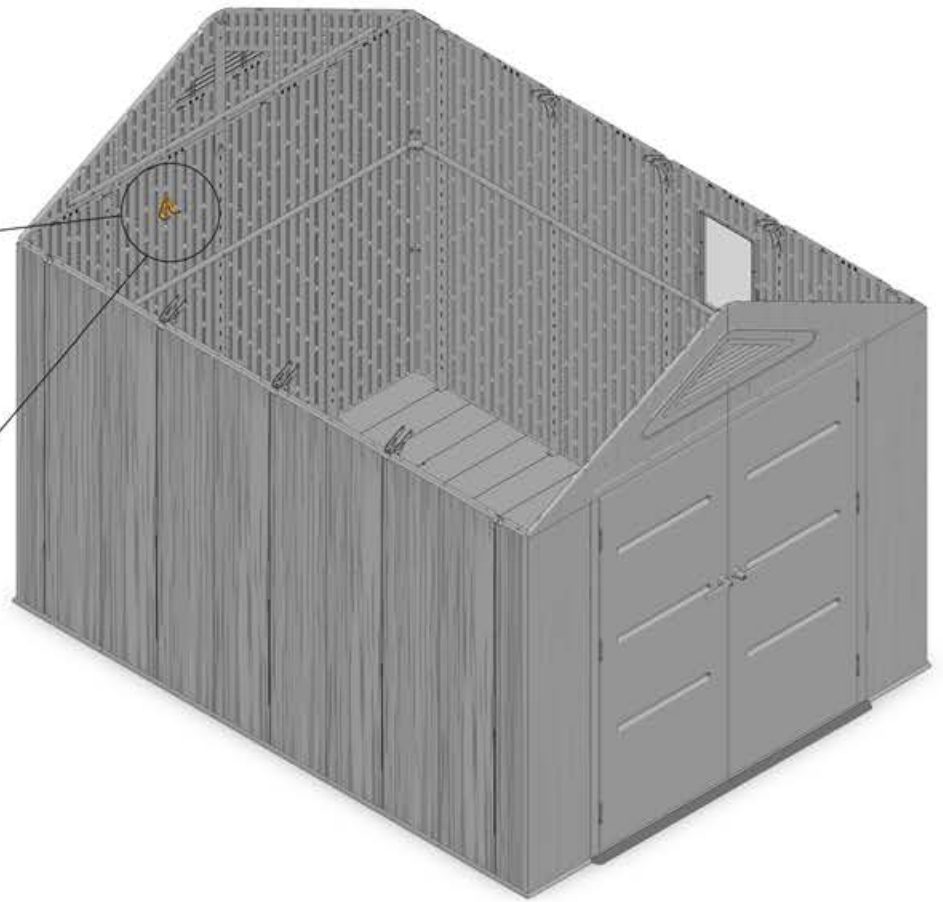
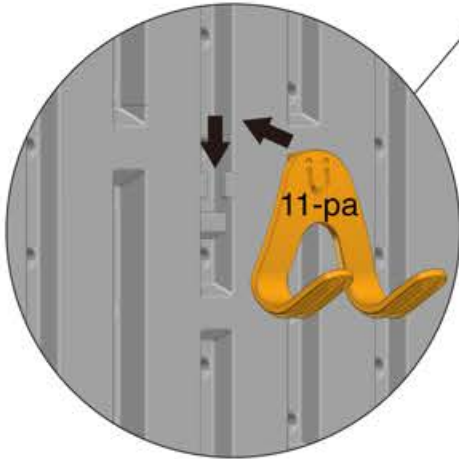
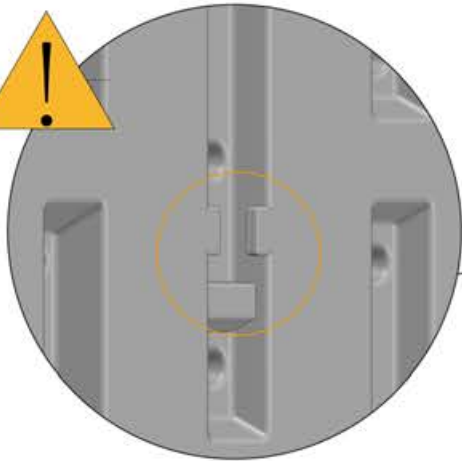

<h1>41</h1>	 <p>19-pa x2</p>
-------------	--

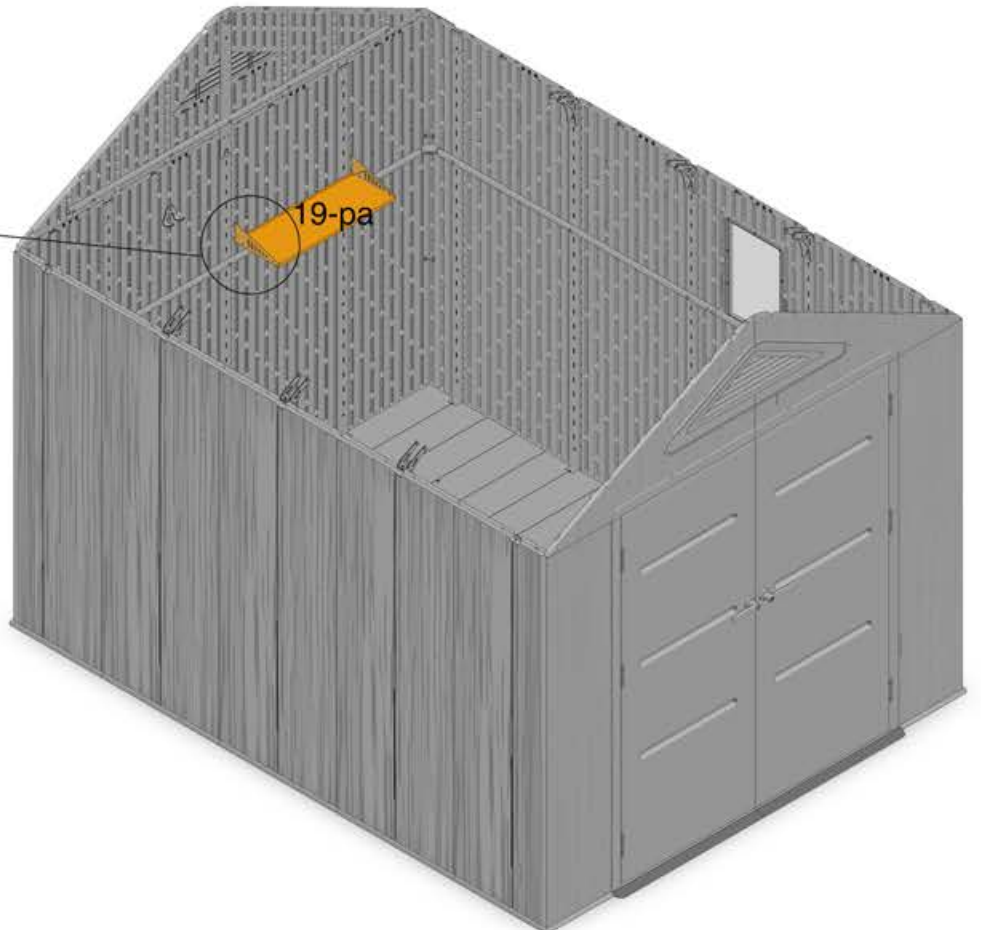
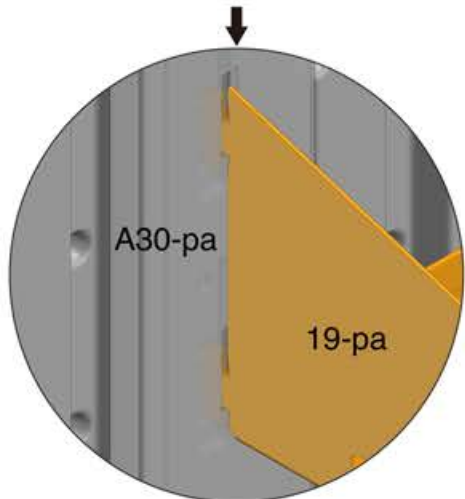
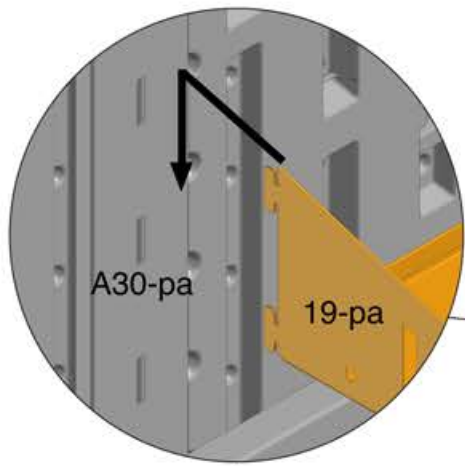
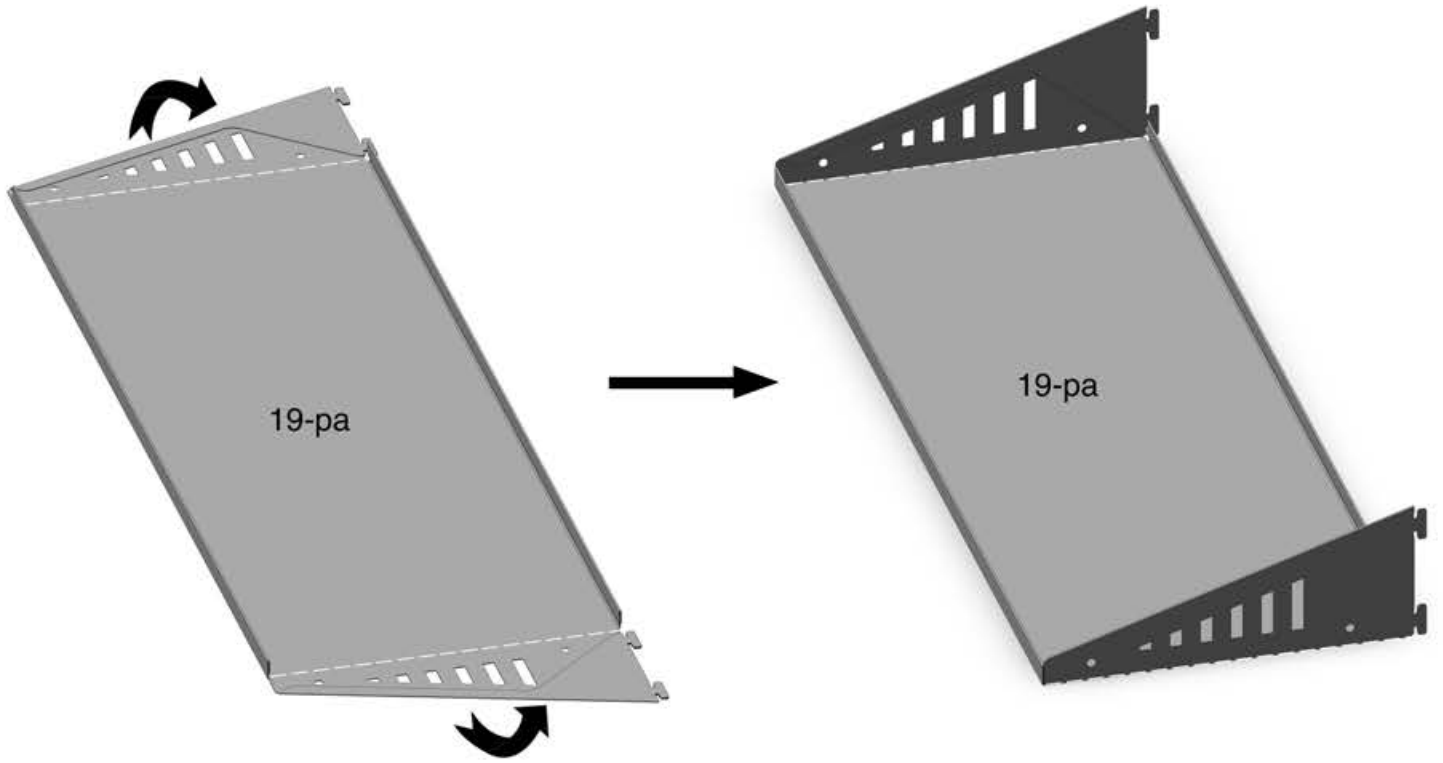

42



C60-pa x15

