

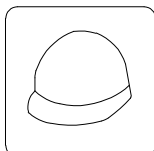

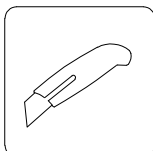

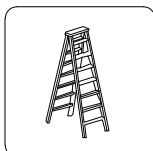

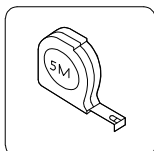

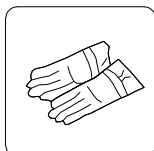
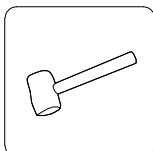
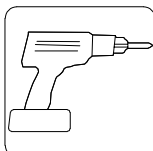
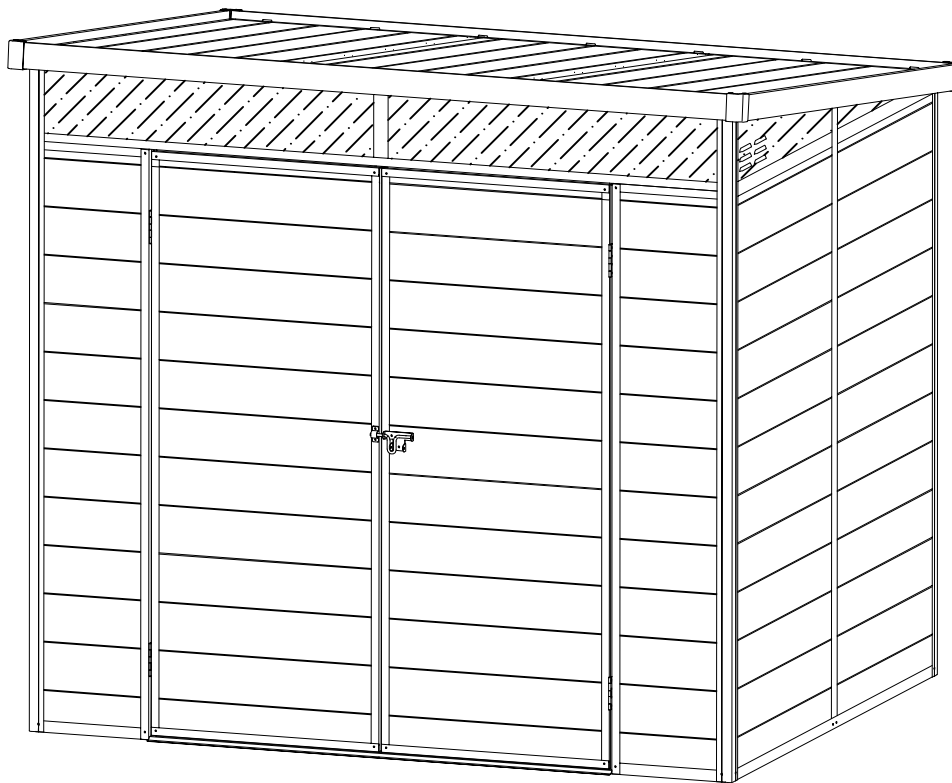
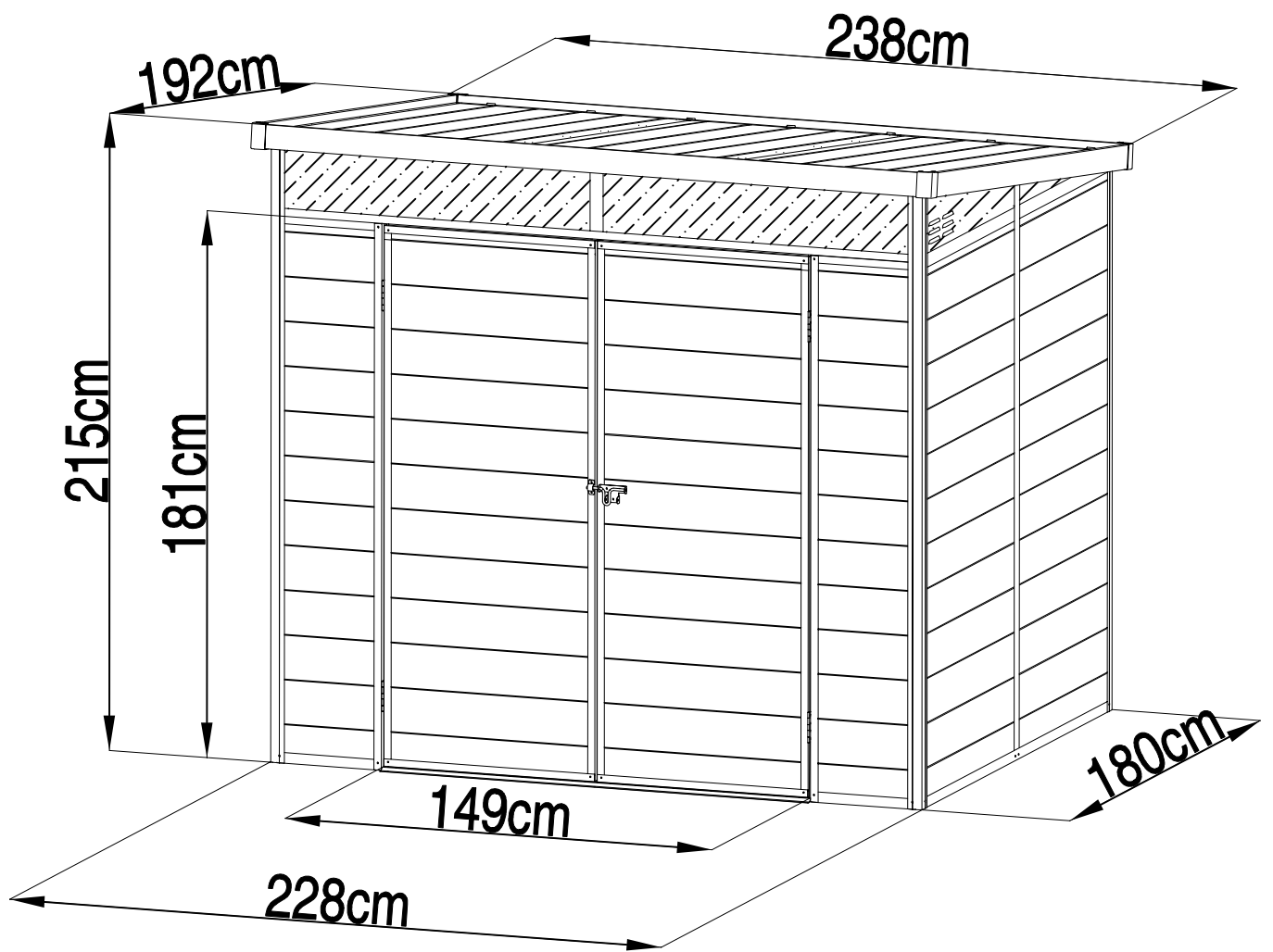



















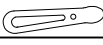























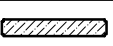

Toya-B

OWNER'S MANUAL /
Instructions for Assembly



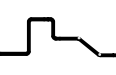

REF	IMAGE	QTY	REF	IMAGE	QTY
XD-B1		x1	XD-A38L		x1
XD-A2		x2	XD-A38R		x1
XD-B3L		x1	XD-1		x4
XD-B3R		x1	XD-2		x4
XD-B4		x1	XD-3		x2
XD-A5L		x1	XD-5		x1
XD-A5R		x1	XD-6		x4
XD-A6L		x1	XD-7		x1
XD-A6R		x1	XD-8		x1
XD-A7		x2	XD-9		x4
XD-A8L		x1	XD-10a		x1
XD-A8R		x1	VA-43		x2
XD-A9		x1	PA01		x3
XD-A10		x1	M-23		x2
XD-A11		x1	CN-A33		x2
XD-B12		x1	XD-B50		x276
XD-A13		x4	XD-B51		x3
XD-B16		x1	XD-B52		x2
XD-B17		x1	XD-B53		x16
XD-A18		x2	XD-B54		x16
XD-B19		x1	XD-B55		x12
XD-B20		x2	XD-B56		x4
XD-B20a		x1	XD-B57		x2
XD-A20b		x2	XD-B58		x2
XD-A21		x1	XD-B59		x4
XD-A22		x1			
XD-A22a		x2			
XD-B23		x4			
XD-B24		x1			
VA-G15		x2			
VA-G14AL		x1			
VA-G14AR		x1			
XD-B27		x1			
XD-B30		x3			
XD-A31		x4			
XD-B32		x2			
XD-B33		x2			
XD-B34a		x1			
XD-B34b		x2			
XD-A35		x2			
XD-B36		x2			
XD-A37		x2			

1	 XD-B1 x1	 XD-A2 x2	 XD-B3L x1	 XD-B3R x1	 XD-B4 x1	 XD-1 x4	 XD-B50 x20
----------	---	---	--	--	--	--	---

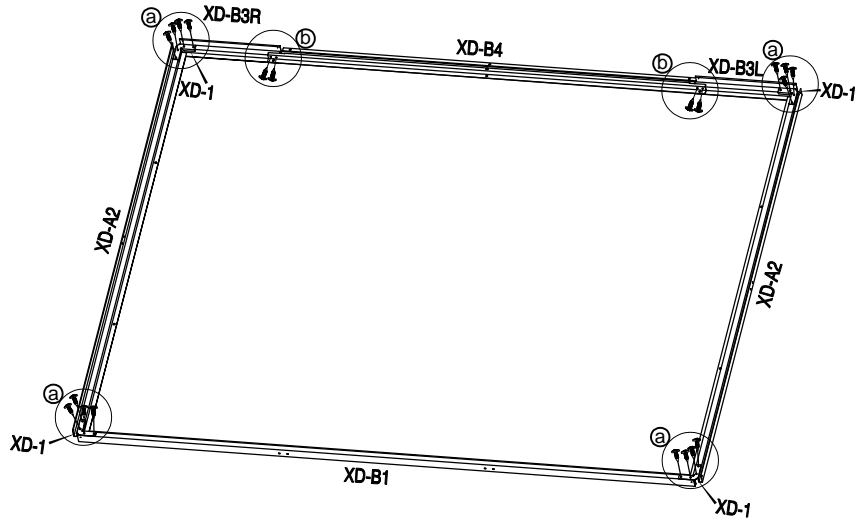
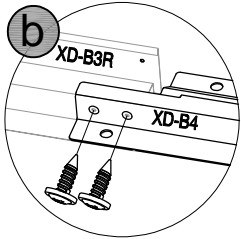
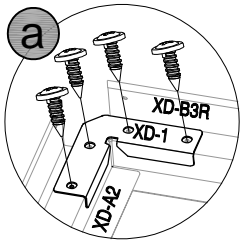

2	 XD-A5L x1						
----------	--	--	--	--	--	--	--

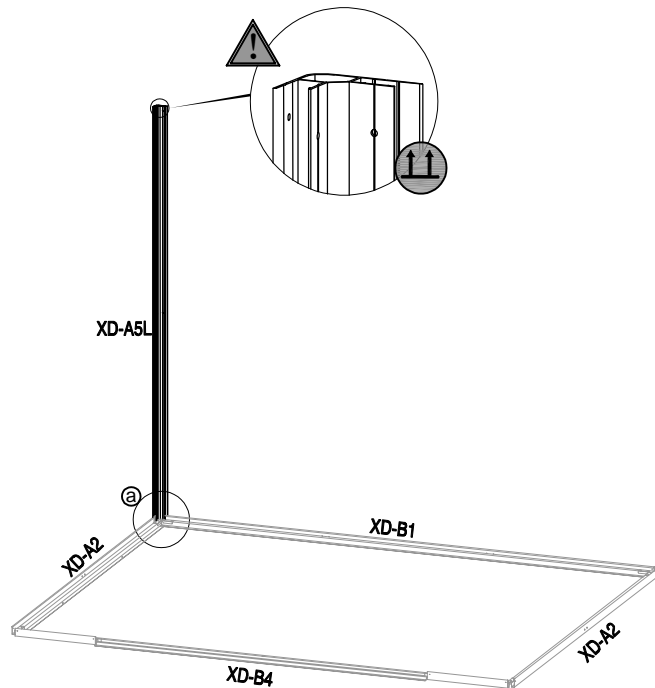
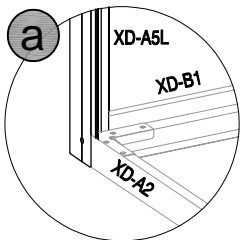
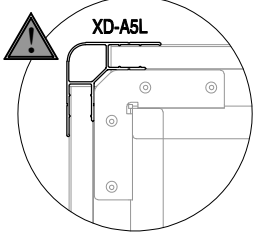



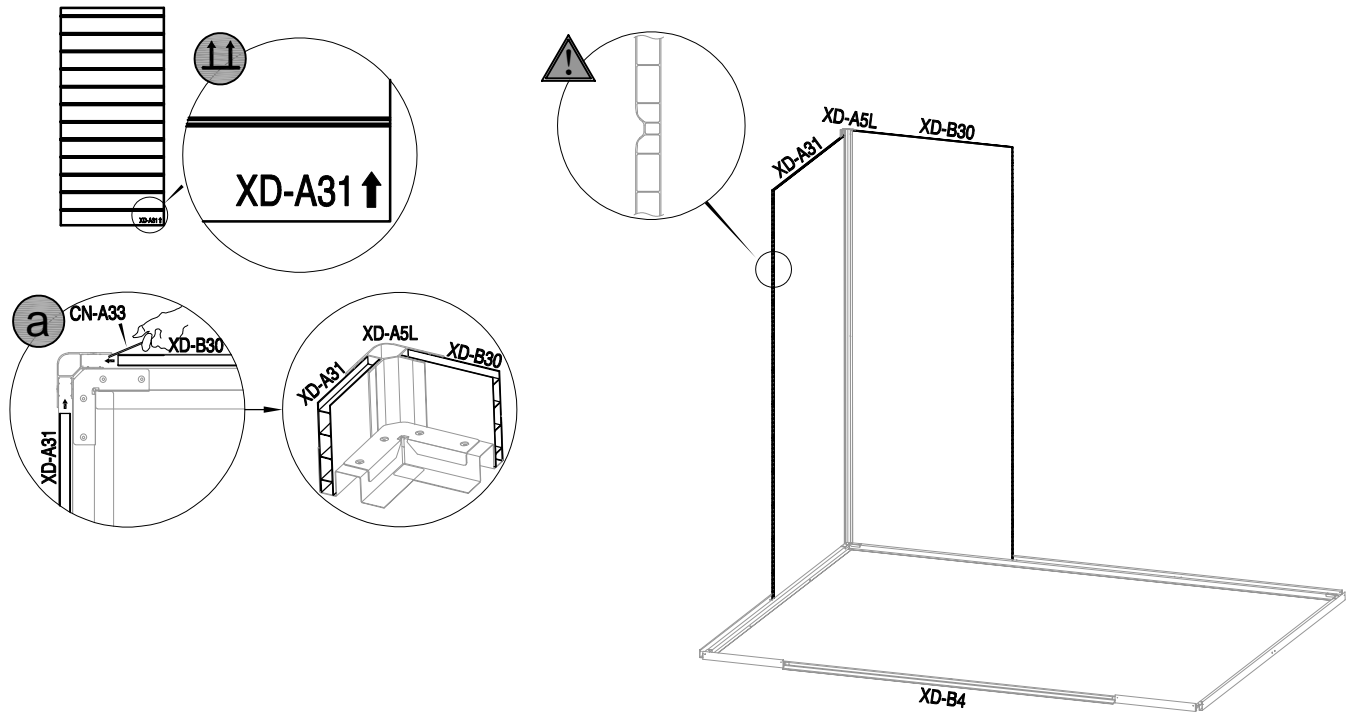

3	 XD-B30 x1	 XD-A31 x1					 CN-A33
---	--	--	--	--	--	--	---

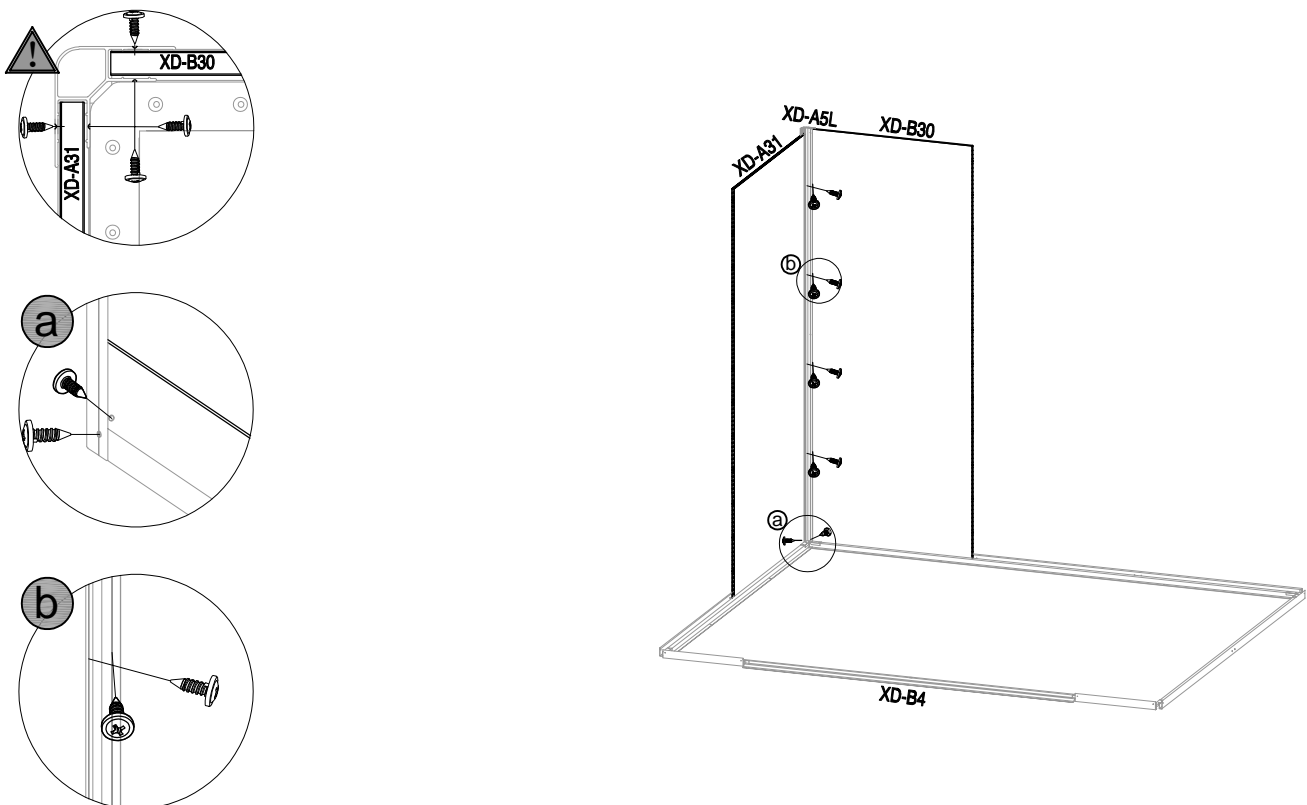





4	 XD-B50 x10						
---	---	--	--	--	--	--	--

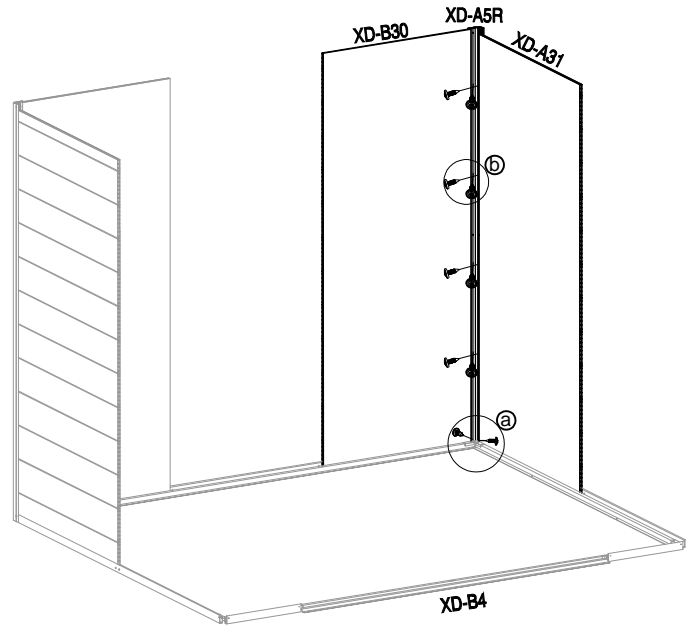
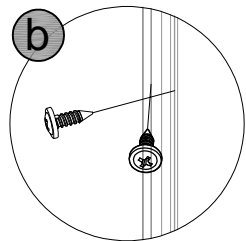
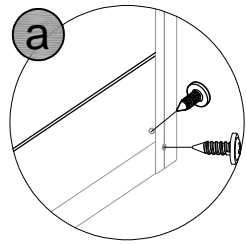
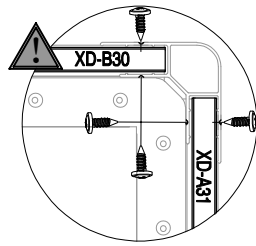
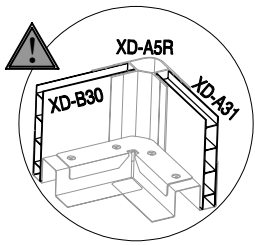





5	 XD-A5R x1	 XD-B30 x1	 XD-A31 x1	 XD-B50 x10			 CN-A33
---	--	--	--	---	--	--	---

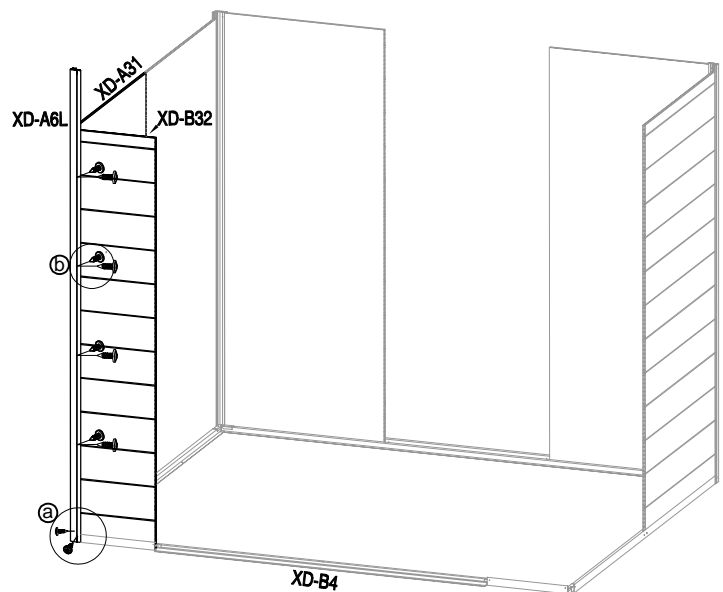
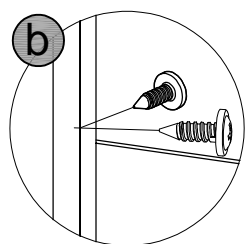
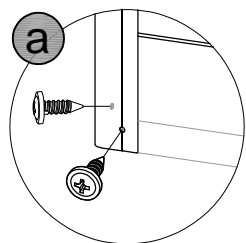
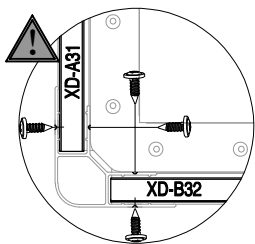

6	 XD-A6L x1	 XD-A31 x1	 XD-B32 x1	 XD-B50 x10			 CN-A33
---	--	--	--	---	--	--	---



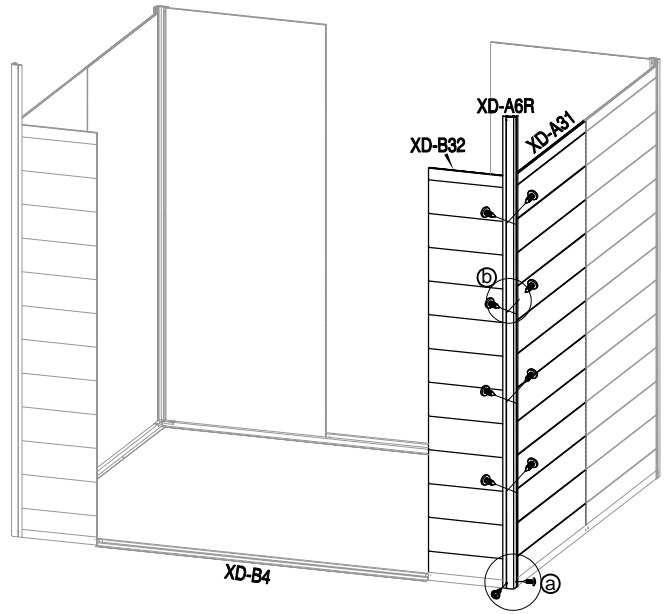
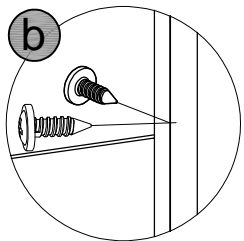
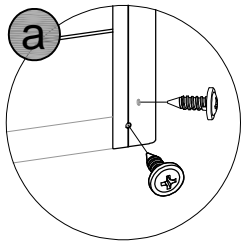
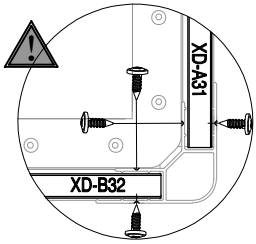

7	 XD-A6R x1	 XD-A31 x1	 XD-B32 x1	 XD-B50 x10			 CN-A33
---	--	--	--	---	--	--	---

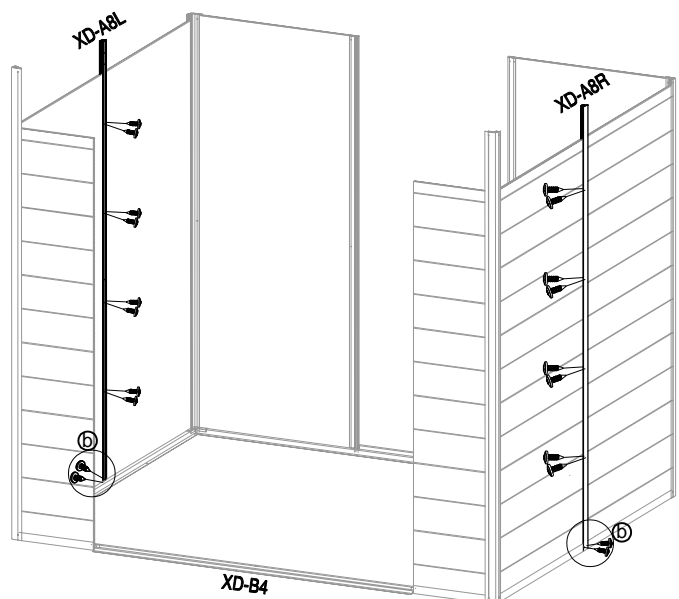
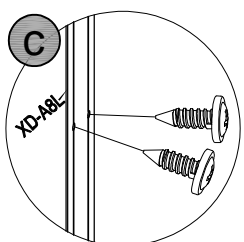
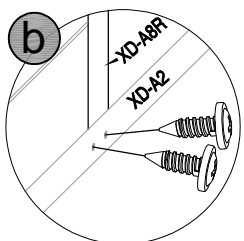
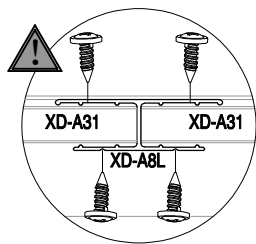
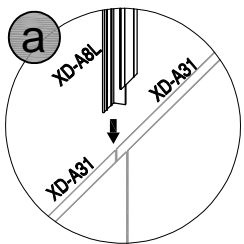

8	 XD-A8L x1	 XD-A8R x1	 XD-B50 x20				 CN-A33
---	--	--	---	--	--	--	---



9							 CN-A33
	XD-A7 x2	XD-B30 x1					

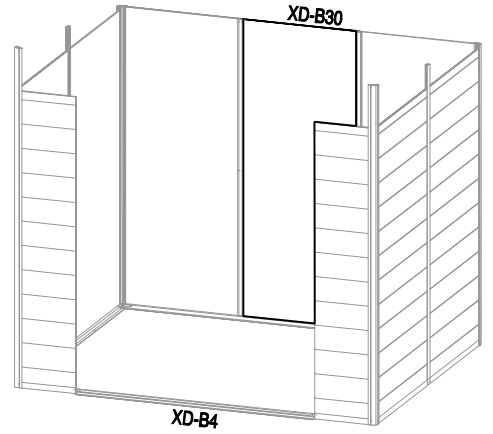
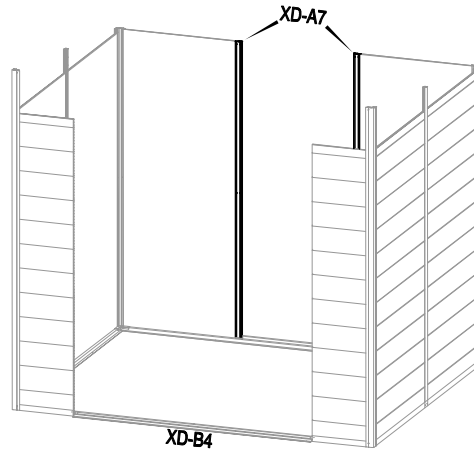
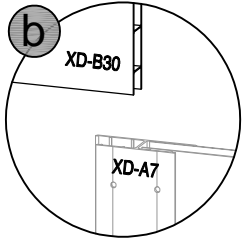
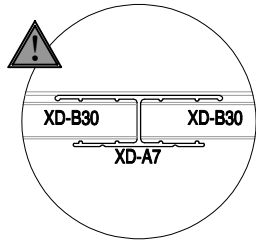
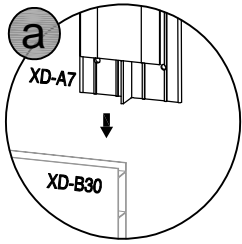

10							 CN-A33
	XD-B50 x20						

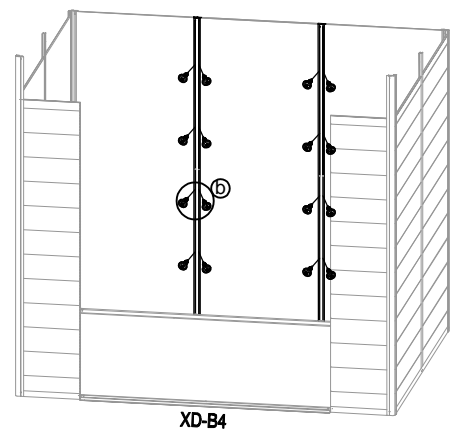
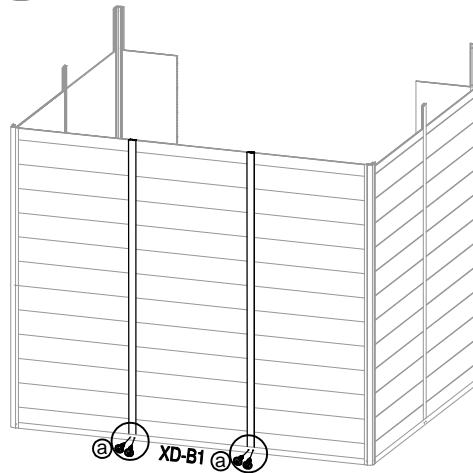
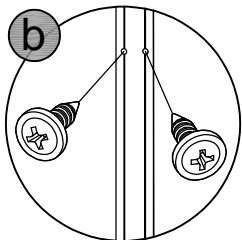
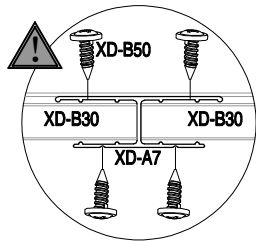
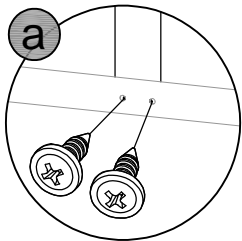

11	 XD-A10 x1	 XD-A11 x1	 XD-B50 x8				
-----------	--	--	--	--	--	--	--

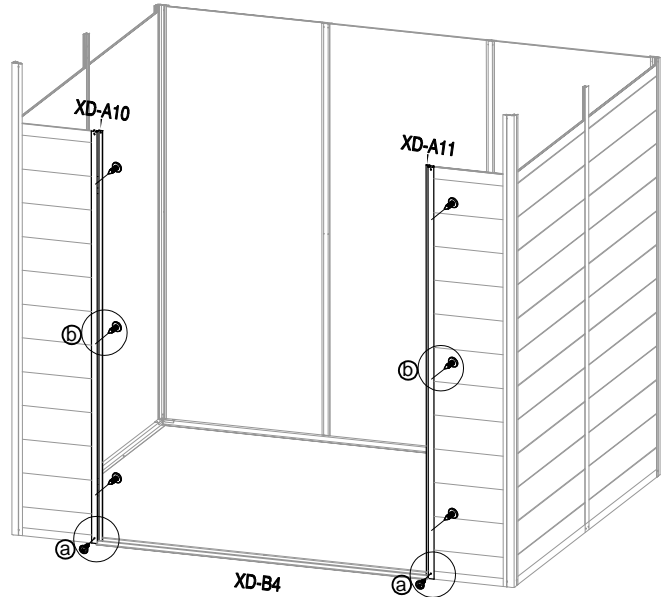
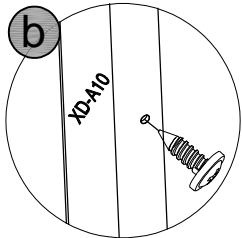
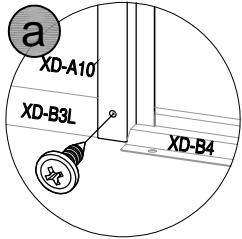
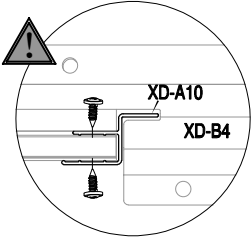

12	 XD-B20 x2	 XD-B50 x2					
-----------	--	--	--	--	--	--	--

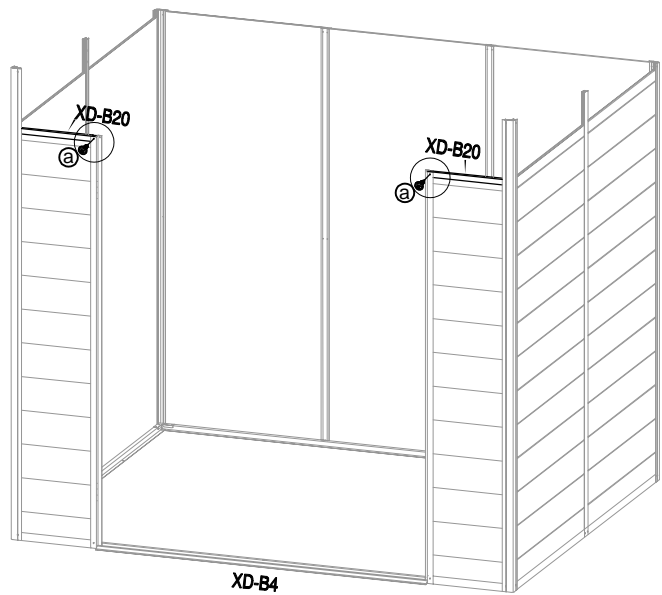
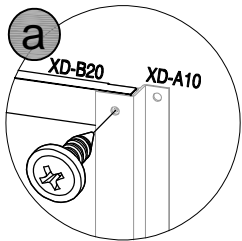



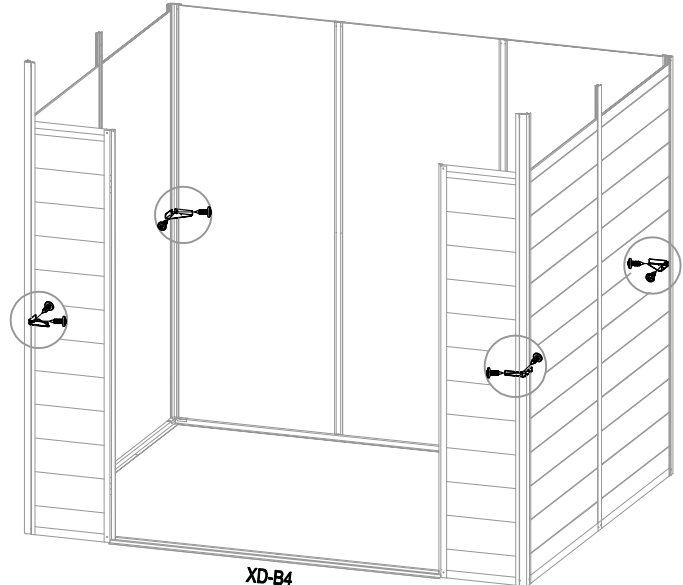
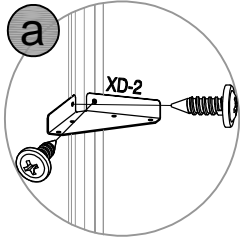

13	 XD-2 x4	 XD-B50 x8					
-----------	--	--	--	--	--	--	--

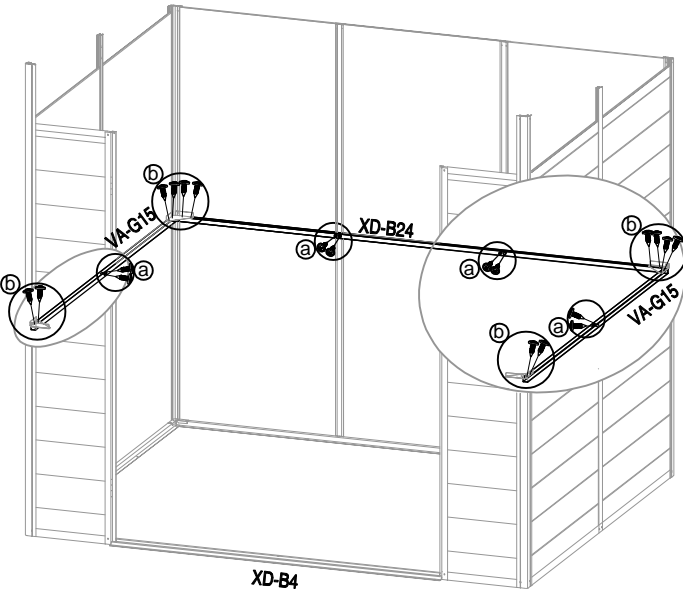
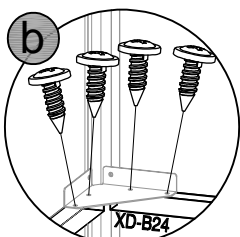
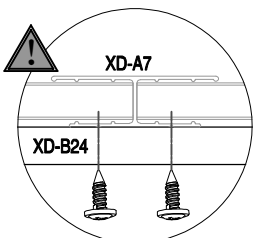
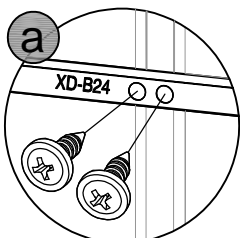

14	 XD-B24 x1	 VA-G15 x2	 XD-B50 x20				
-----------	--	--	---	--	--	--	--



15							
	VA-G14AL x1	VA-G14AR x1	VA-43 x2	XD-B50 x6			

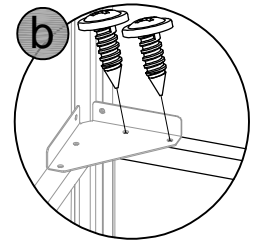
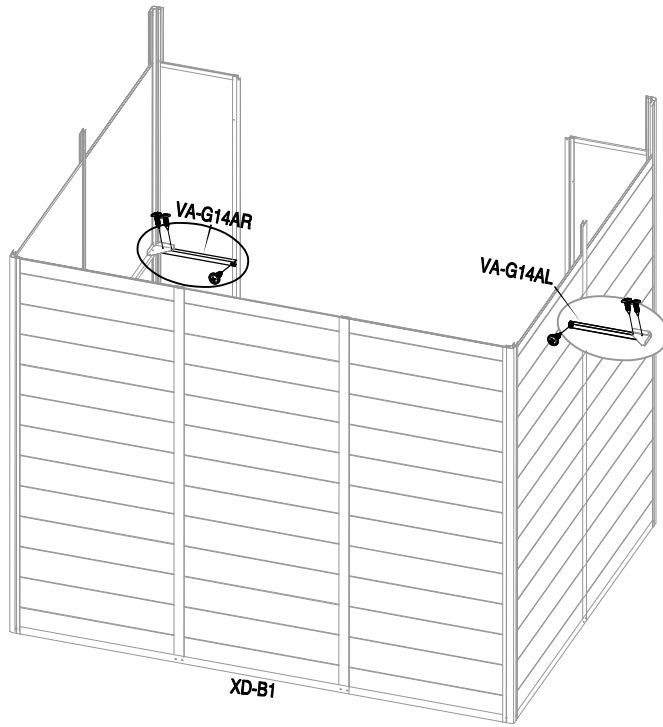
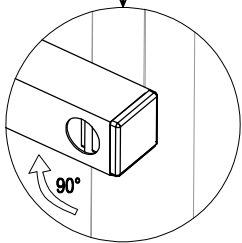
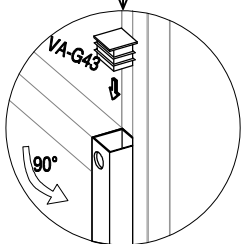
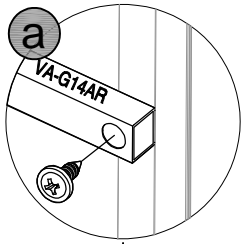

16							
	XD-B12 x1	XD-B50 x4	XD-B58 x2				

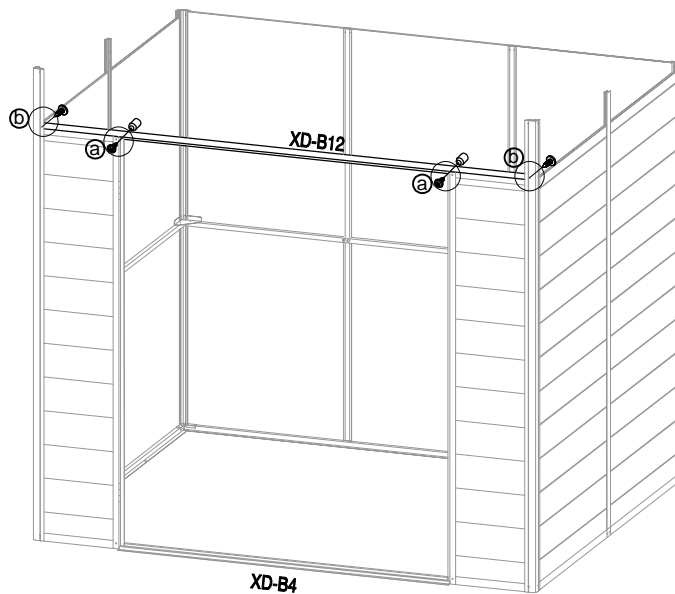
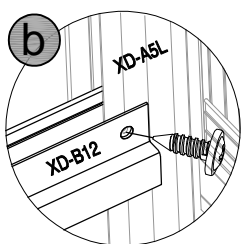
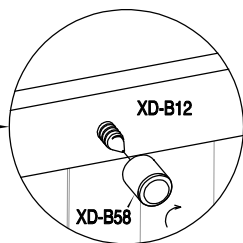
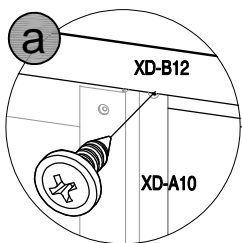
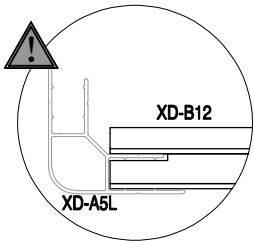

17							
	XD-B27 x1						

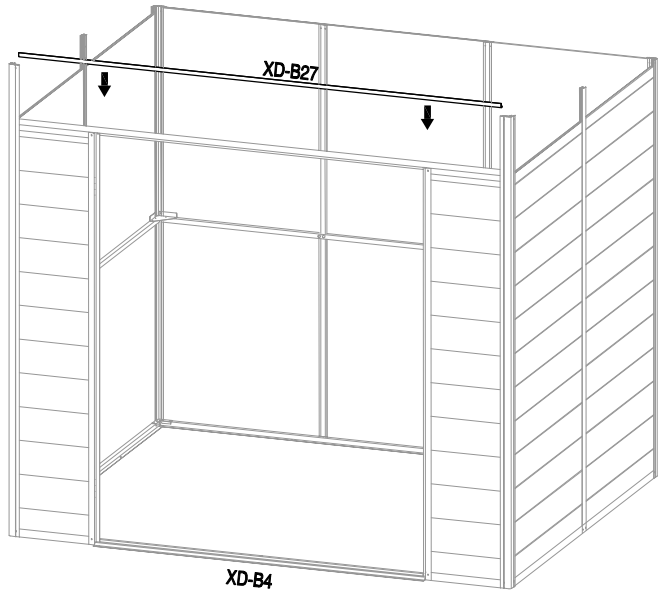
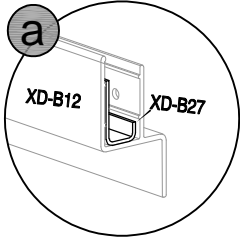



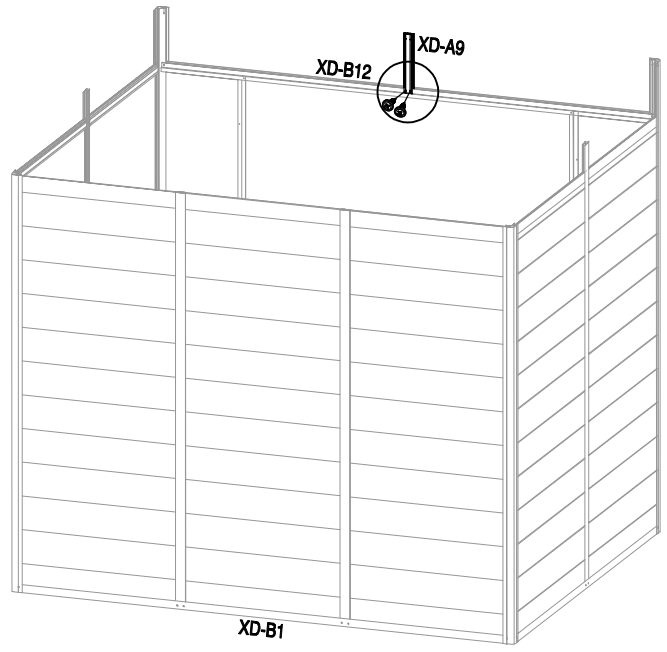
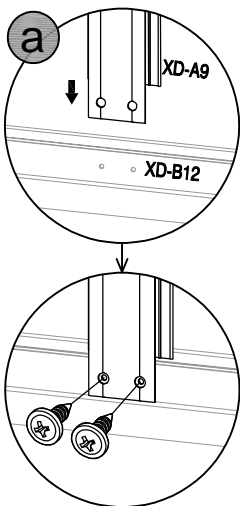

18							
	XD-A9 x1	XD-B50 x2					

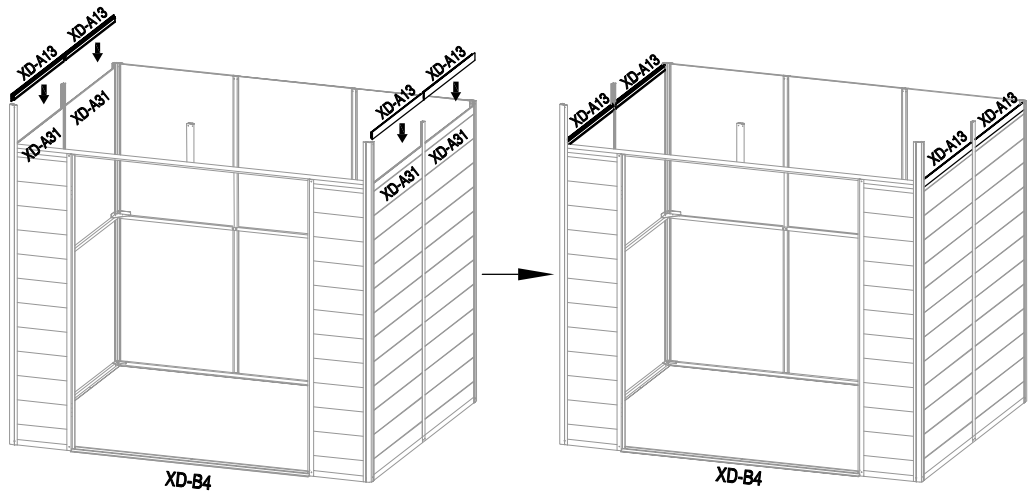
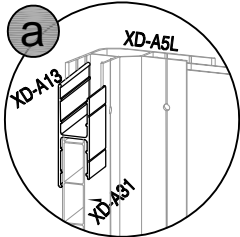
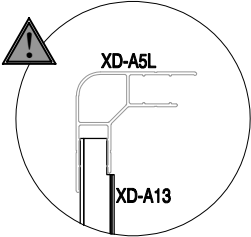

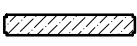
19							
XD-A13 x4							





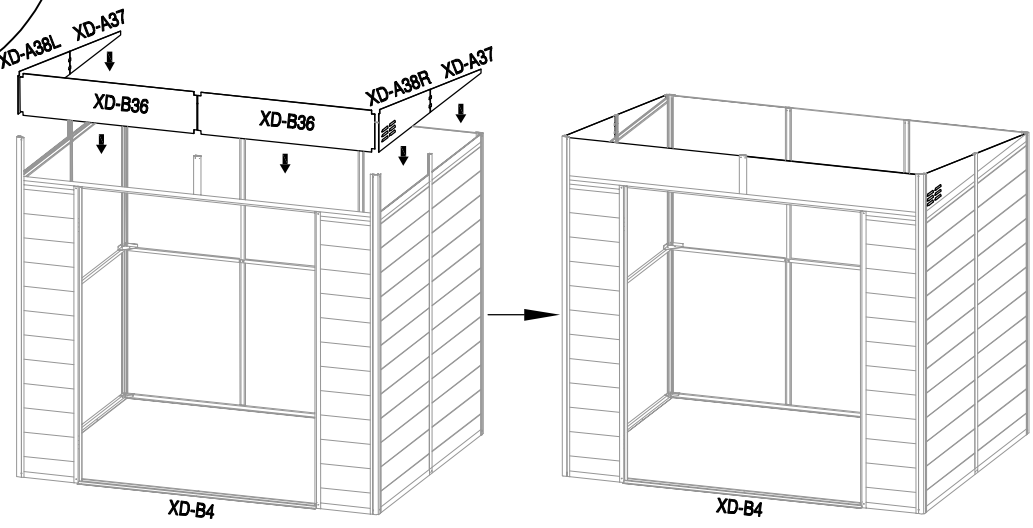
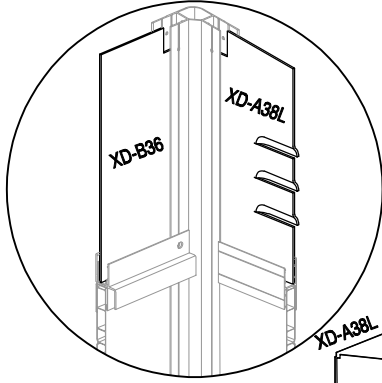

20							
XD-B36 x2		XD-A37 x2	XD-A38L x1	XD-A38R x1			

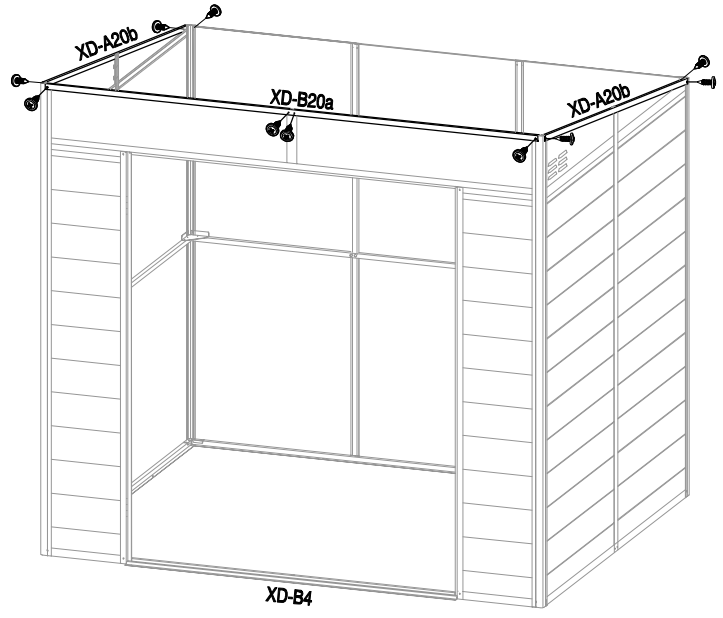
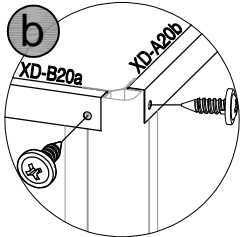
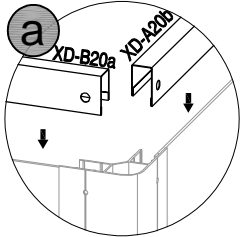





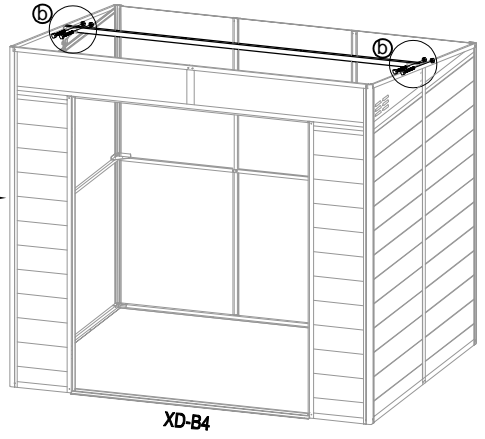
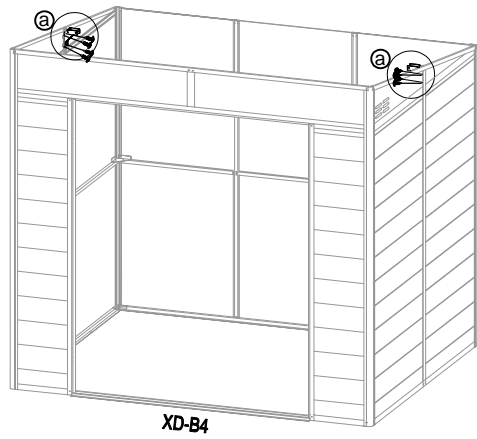
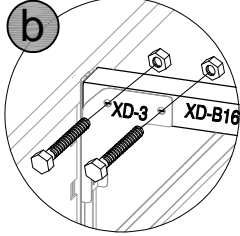
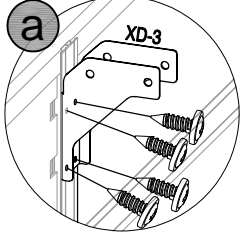

21	 XD-B20a x1	 XD-A20b x2	 XD-B50 x10				
-----------	---	---	---	--	--	--	--



22	 XD-3 x2	 XD-B16 x1	 XD-B50 x8	 XD-B56 x4			
-----------	--	--	--	--	--	--	--



23	 XD-B34a x1	 XD-B34b x2	 XD-A35 x2	 XD-B57 x2	 XD-B50 x24		 CN-A33
----	---	---	--	--	---	--	---

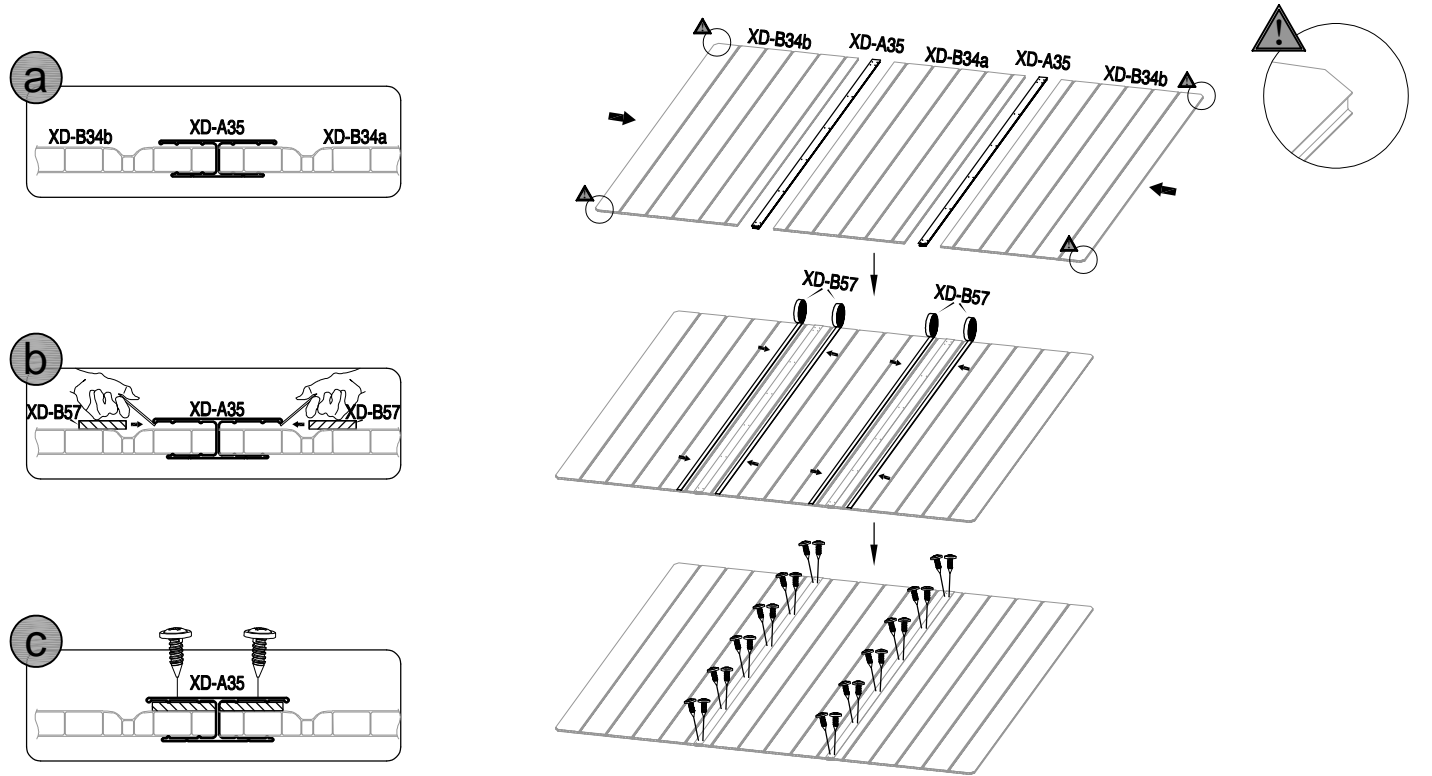

24	 XD-A18 x2						
----	--	--	--	--	--	--	--

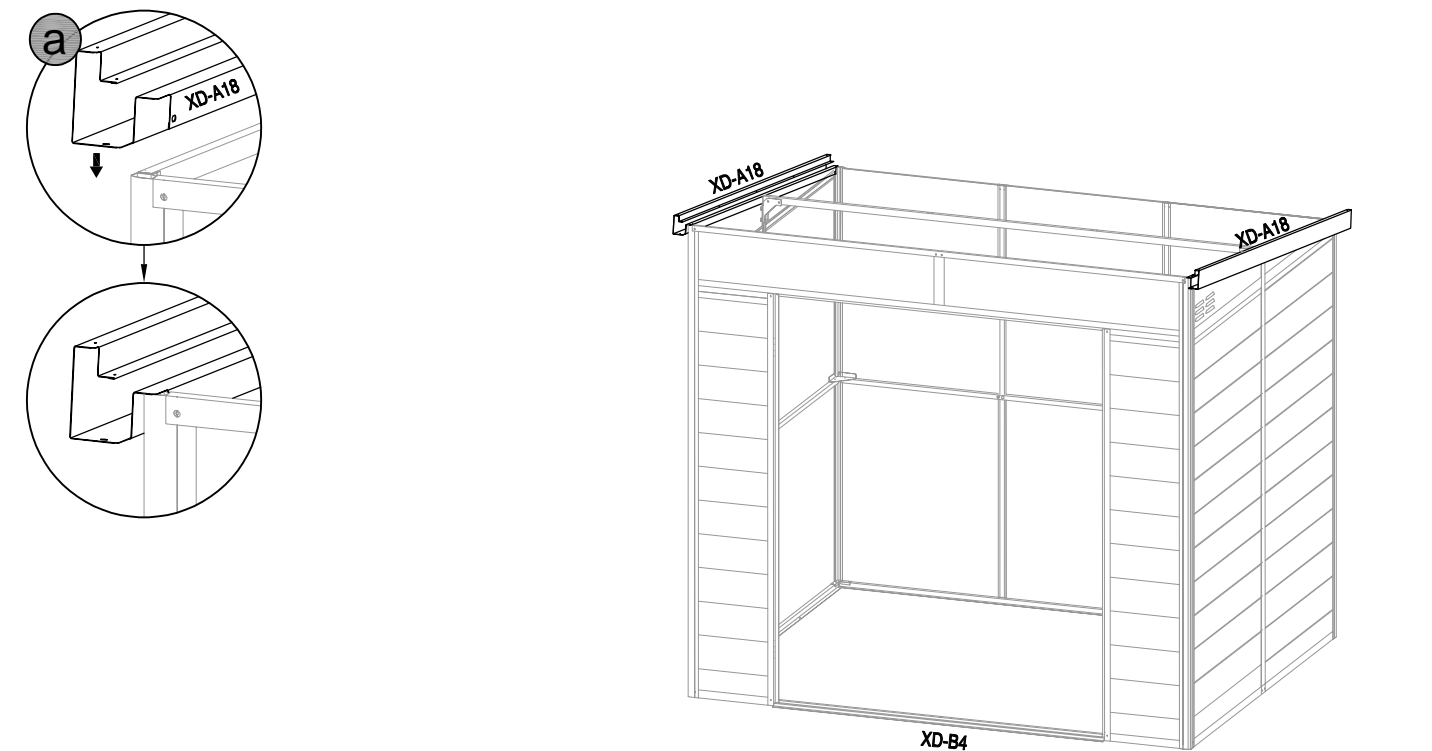

25	 XD-B17 x1	 M-23 x2					
----	--	--	--	--	--	--	--

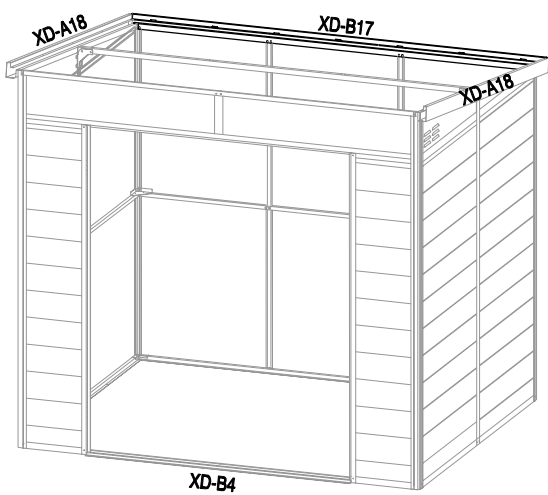
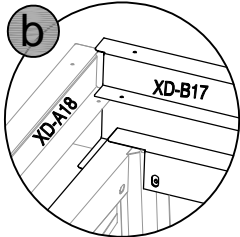
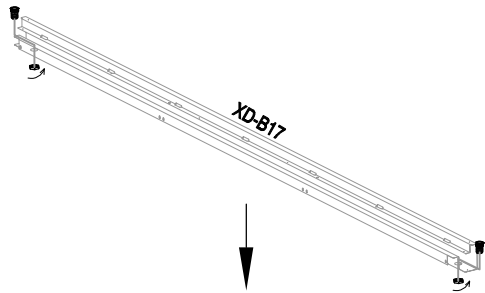
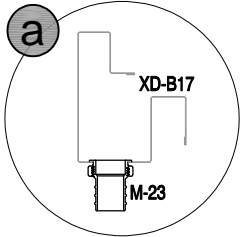

26							
----	--	--	--	--	--	--	--

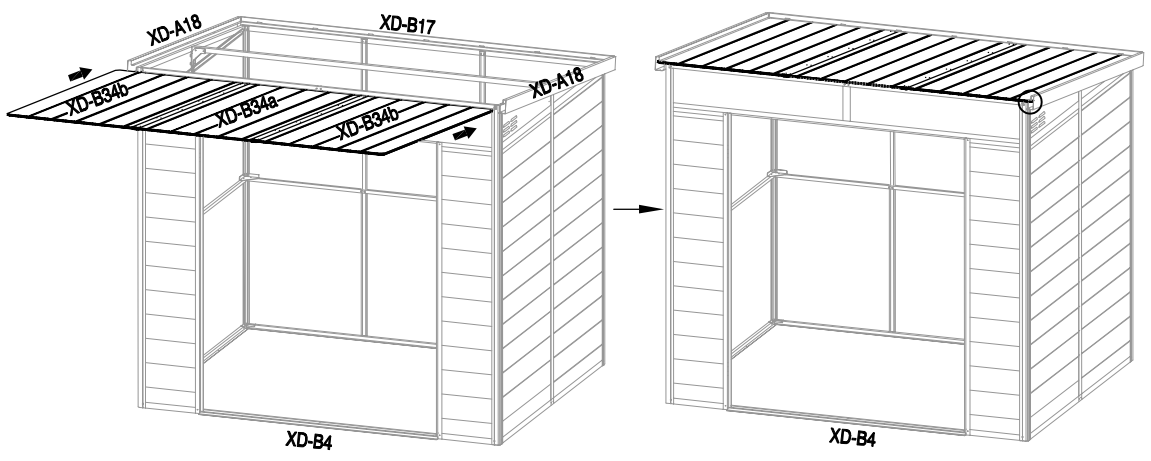
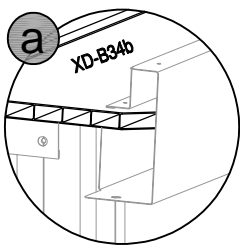
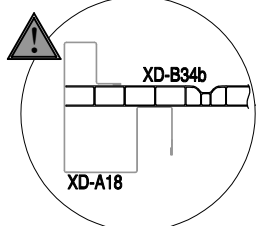

27	 XD-B19 x1	 XD-B50 x4					
----	--	--	--	--	--	--	--

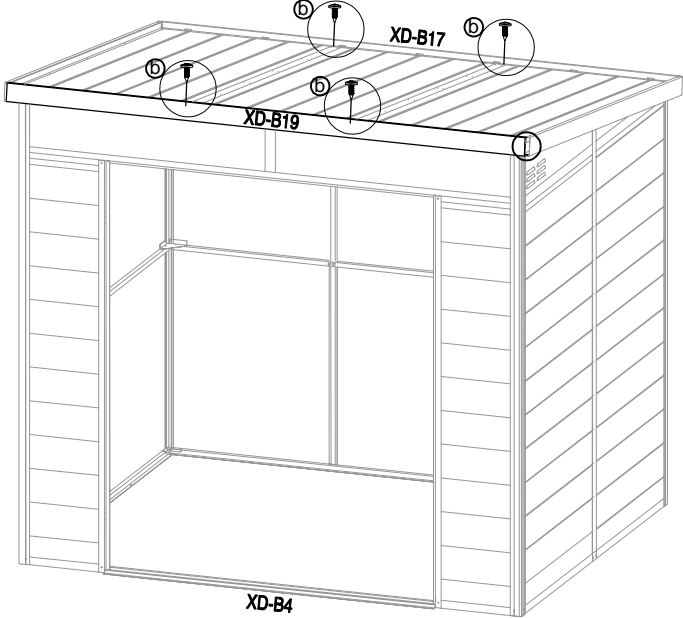
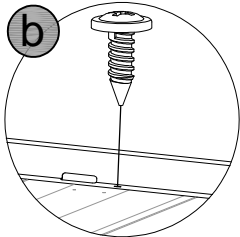
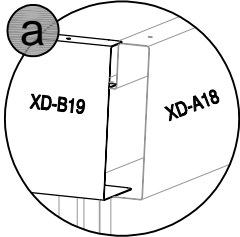

28	 XD-B50 x18						
----	---	--	--	--	--	--	--

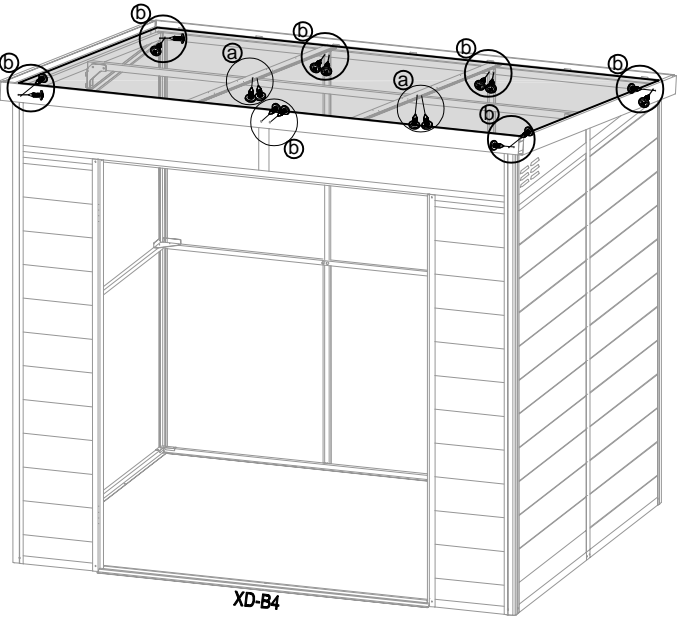
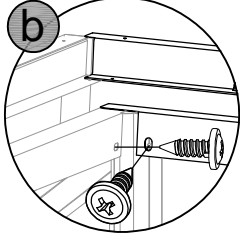
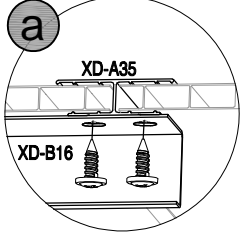



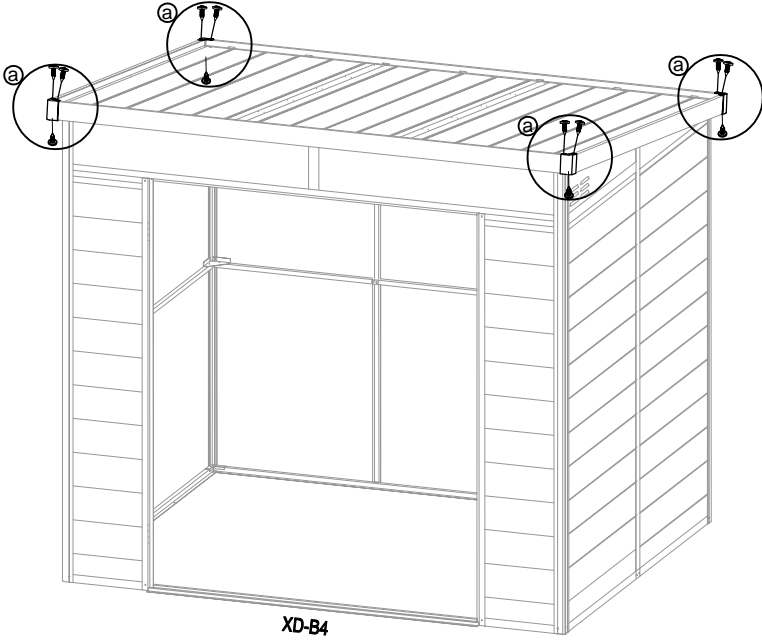
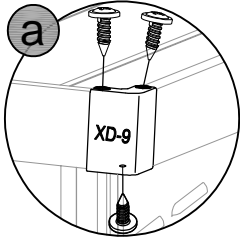

29	 XD-9 x4	 XD-B50 x12					
-----------	--	---	--	--	--	--	--

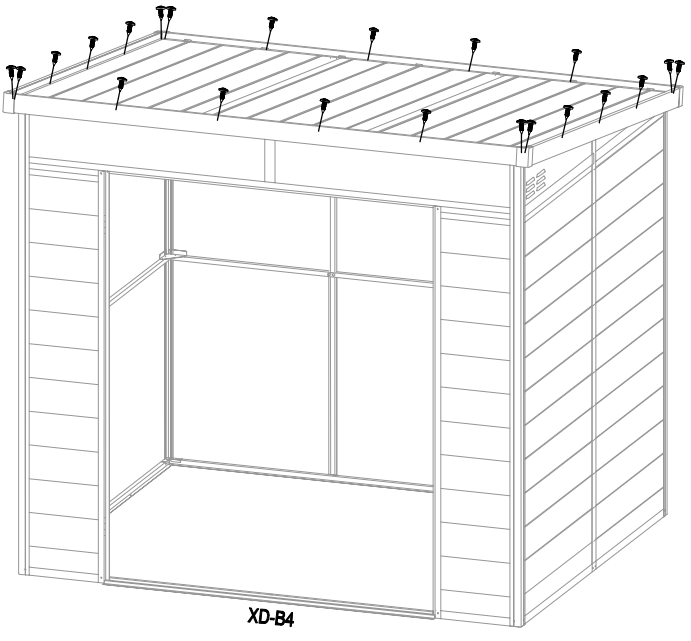
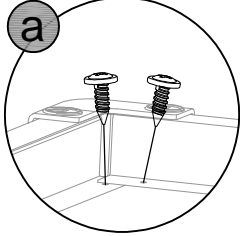
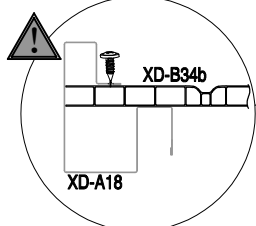

30	 XD-B50 x22						
-----------	---	--	--	--	--	--	--

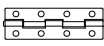



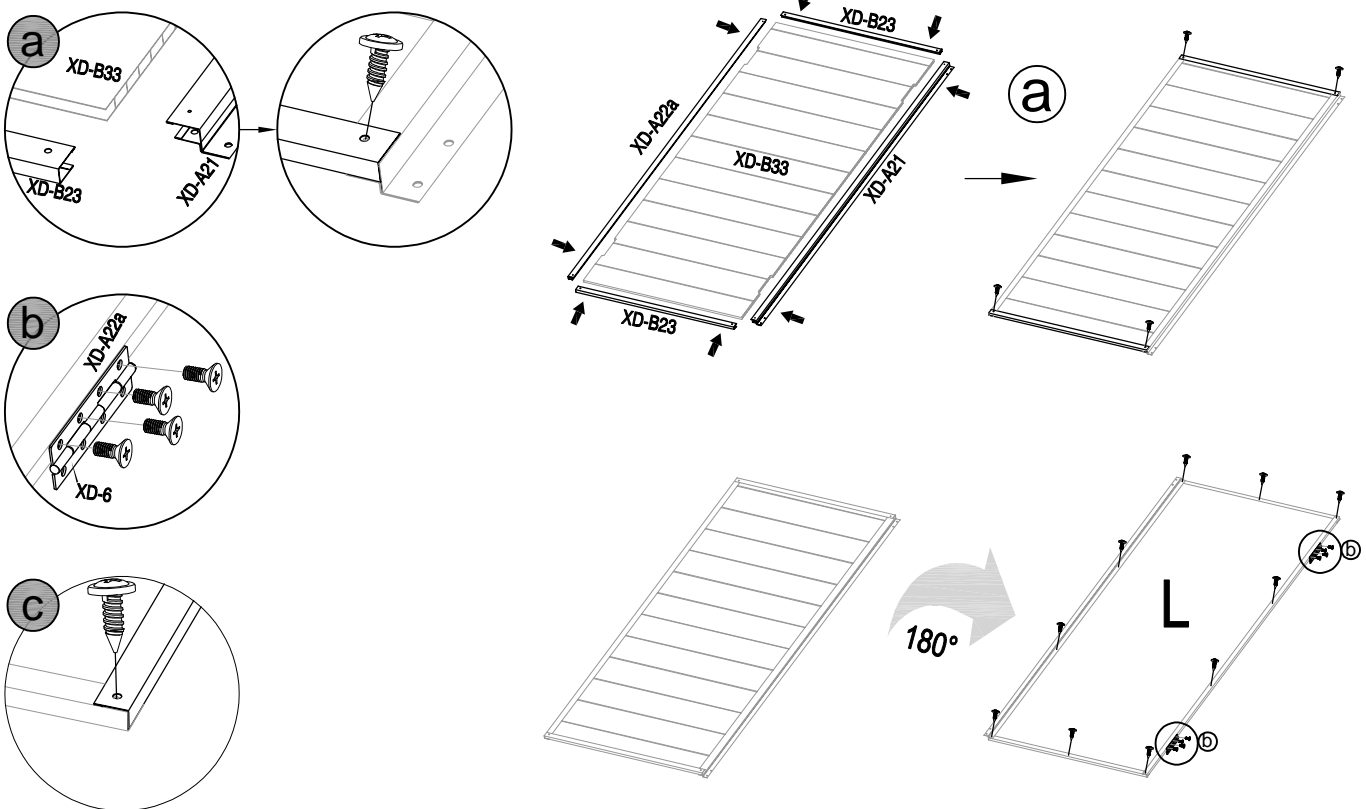

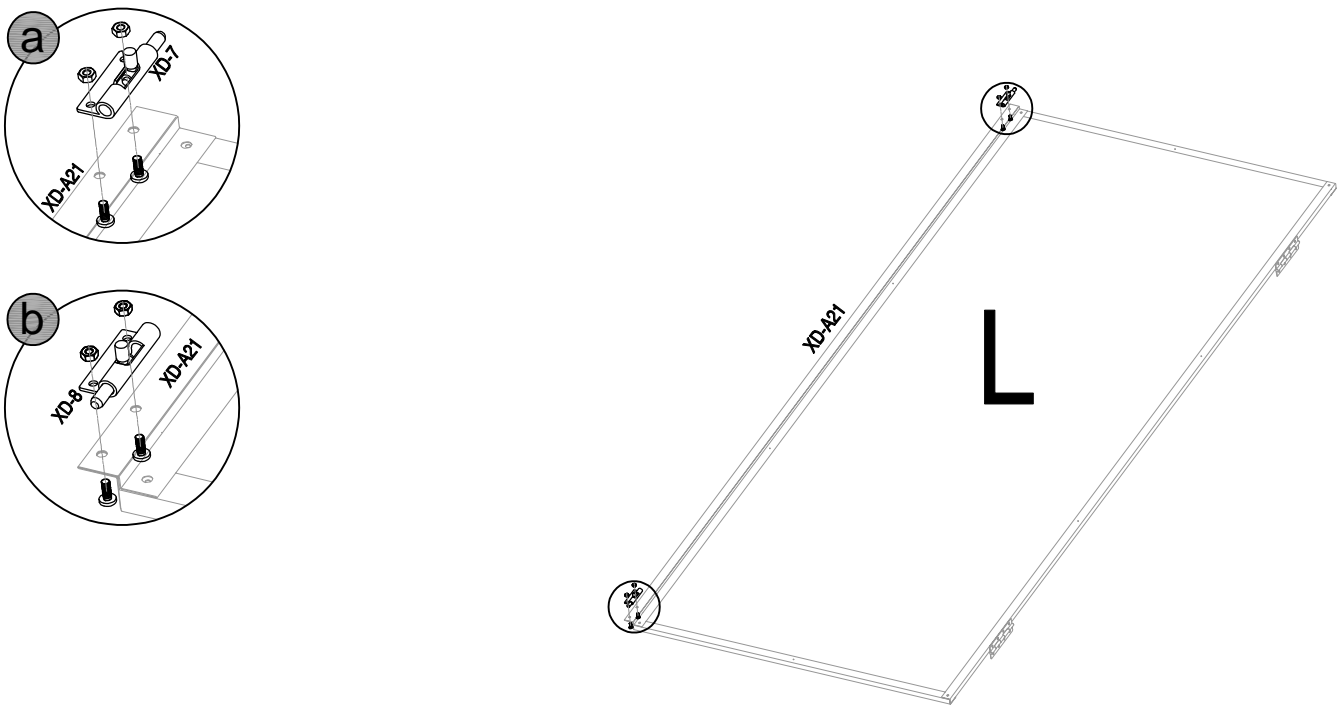

31	 XD-B33 x1	 XD-A21 x1	 XD-A22a x1	 XD-B23 x2	 XD-6 x2	 XD-B50 x14	 XD-B53 x8
----	--	--	---	--	---	---	--



32	 XD-7 x1	 XD-8 x1	 XD-B59 x4				
----	--	--	--	--	--	--	--

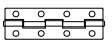



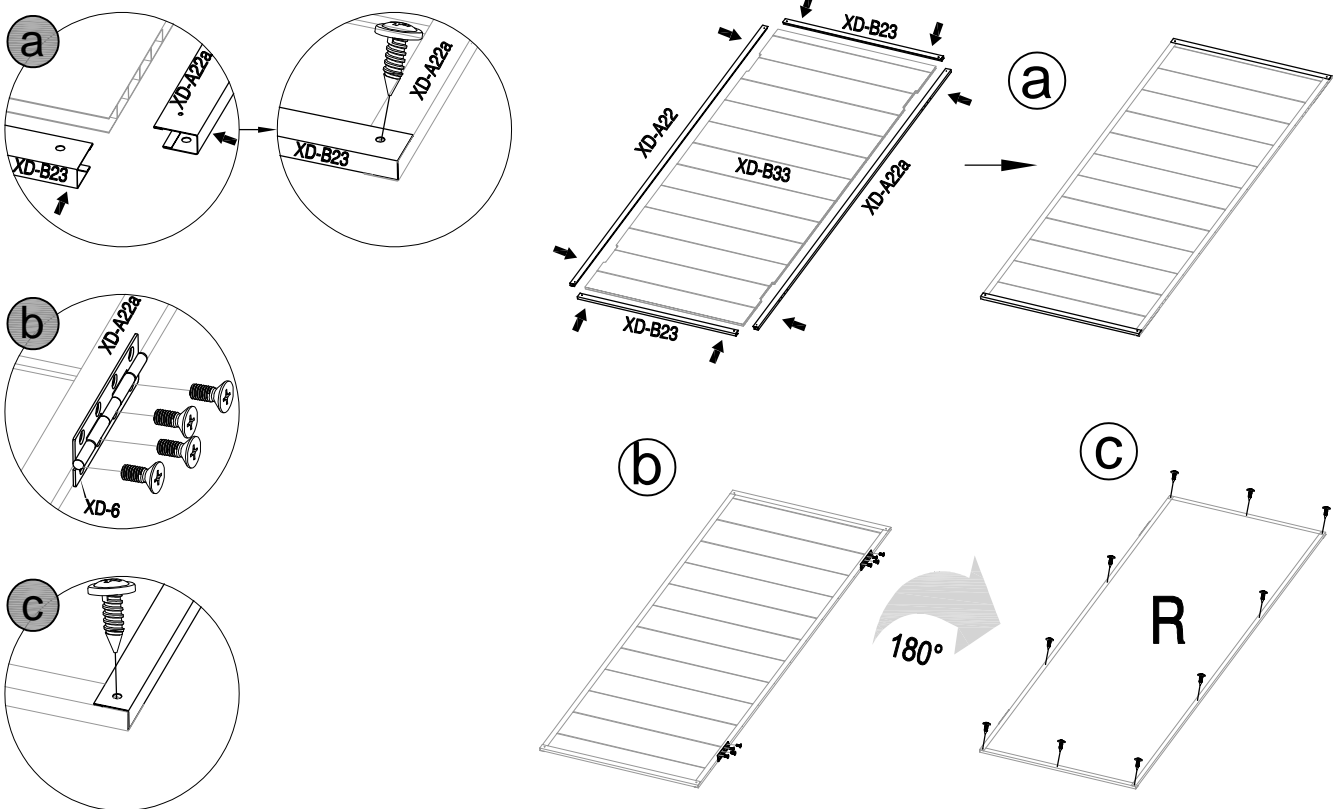

33	 XD-B33 x1	 XD-A22 x1	 XD-A22a x1	 XD-B23 x2	 XD-6 x2	 XD-B50 x14	 XD-B53 x8
----	--	--	---	--	---	---	--

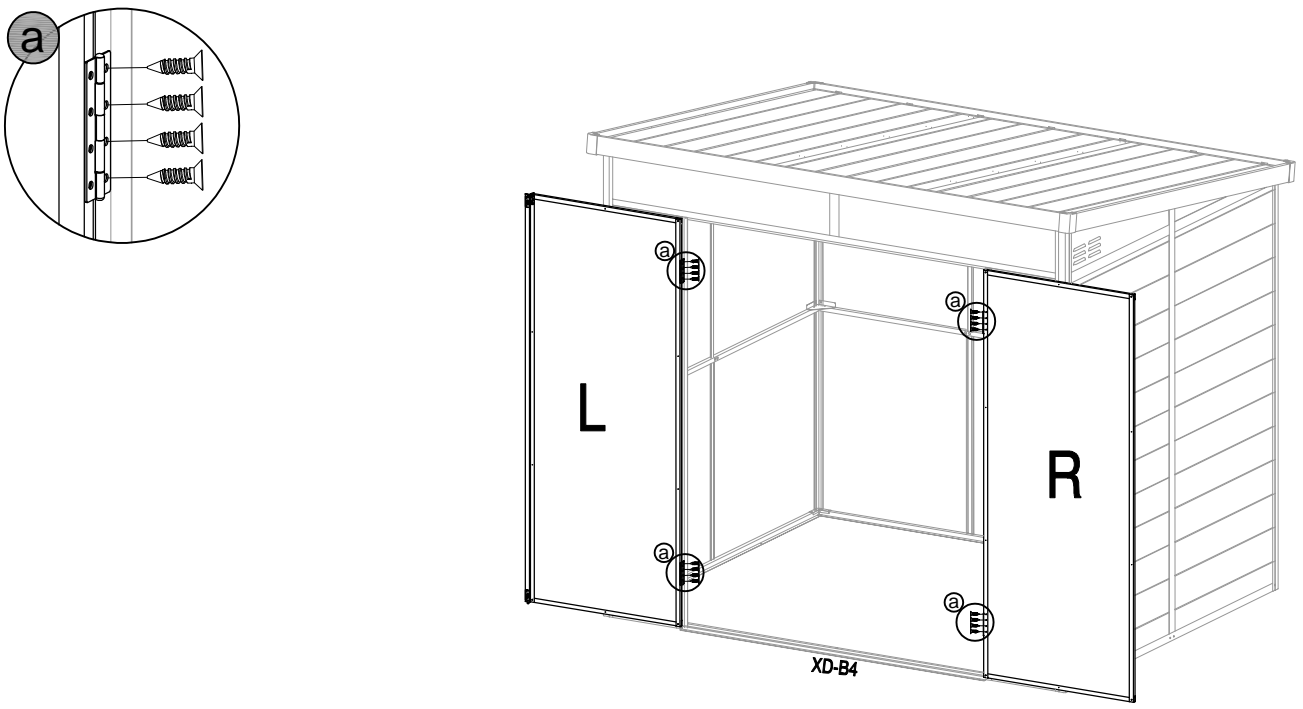

34	 XD-B54 x16						
----	---	--	--	--	--	--	--



35	 XD-5 x1	 PA01 x3	 XD-B51 x3	 XD-B52 x2			
----	--	--	--	--	--	--	--

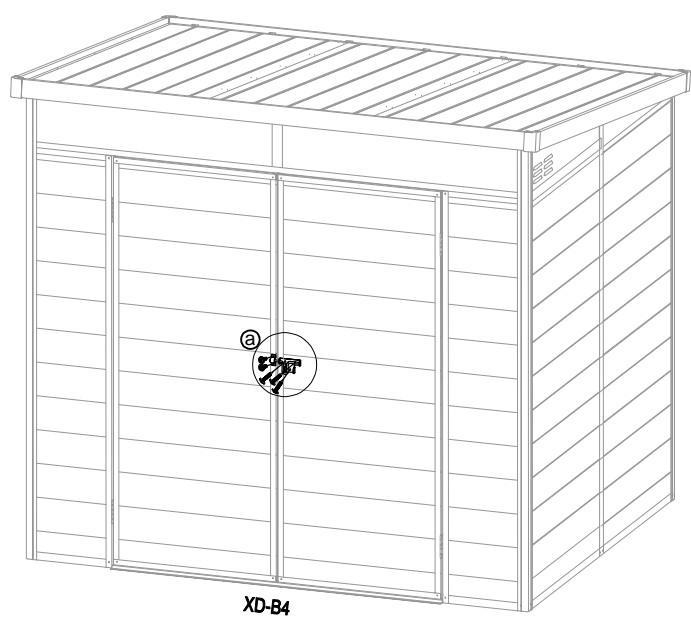
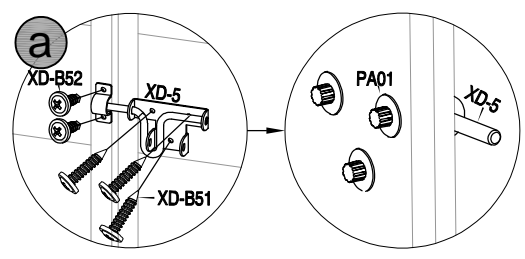
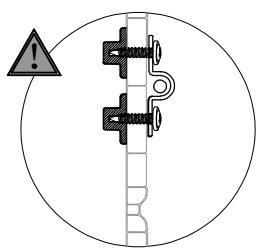

36	 XD-10a x1						
----	--	--	--	--	--	--	--

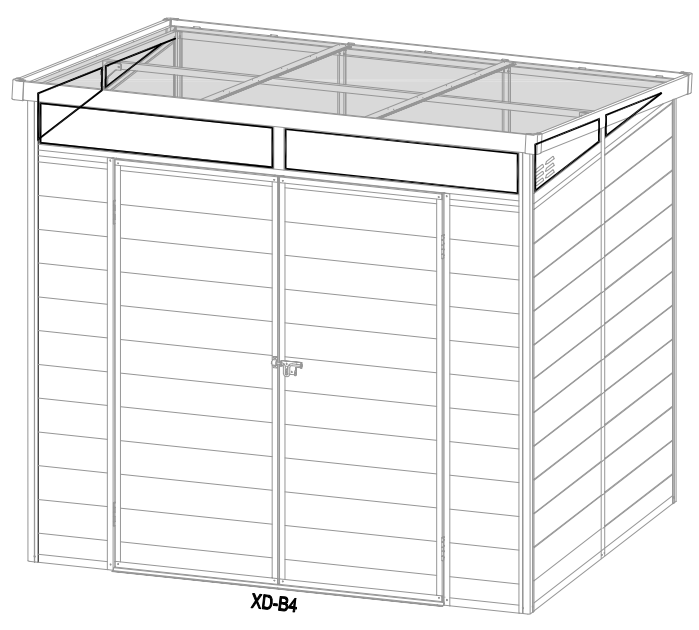
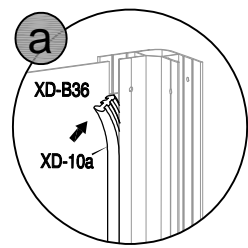
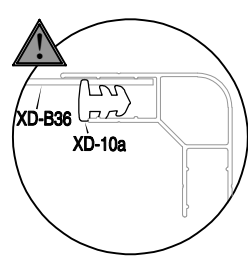

37



XD-B55 x12

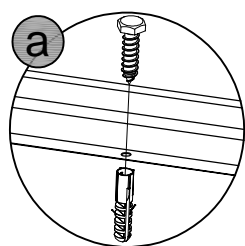
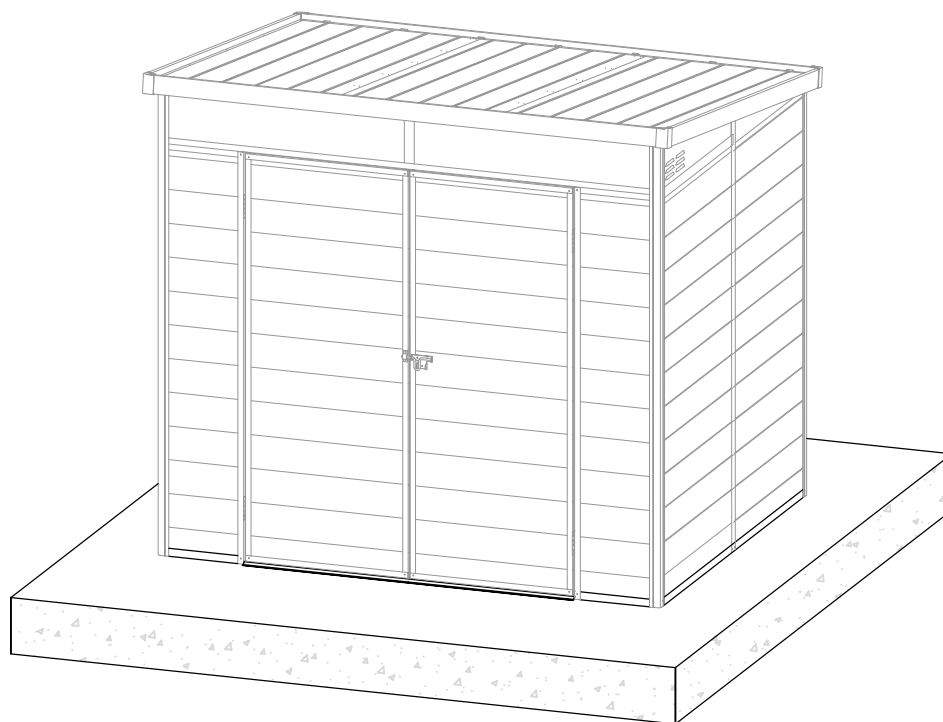

 A=B

