

נא שמרו הוראות אלה



שולחן כדורגל הוראות הרכבה

חשוב!

- יש לעיין היטב במדריך ההרכבה לפני השימוש בשולחן.
- יש לקרוא את כל הוראות הבטיחות לפני השימוש.



שולחן כדורגל איכותי 49 אינץ'

- מידות השולחן: 124x60x79 ס"מ
- משטח משחק מפלטת MDF בעובי 3 מ"מ
- רגלי עץ מאסיביות בעובי 15 מ"מ
- מוטות פלדה בציפוי כרום מבריק
- 13 שחקנים בכל קבוצה

היבואן: פולטון בע"מ | ח.פ. 514832865 | דרך השלום 22, ת"א
טל': 03-5614012 | שנת ייצור: 2025 | ארץ ייצור: סין



לקוחות יקרים

חב' פולטון בע"מ, יבואנית מוצרי הספורט האיכותיים מבית ATHLETIC, מברכת אתכם לרגל רכישת שולחן הכדורגל החדש. אנו בטוחים שתיהנו ממנו לאורך זמן.



אזהרה!











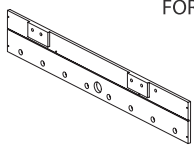
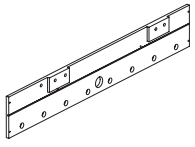
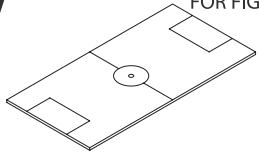
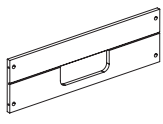

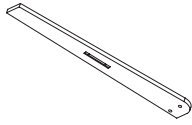
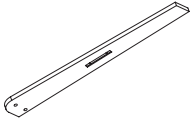

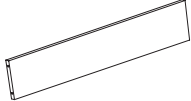
לא לילדים מתחת לגיל 3!
סכנת חנק, מכיל חלקים קטנים!

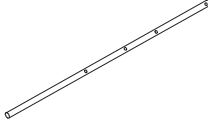
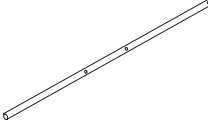
אזהרה: נדרשת הרכבה ע"י מבוגר!

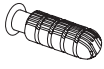
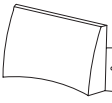

PARTS IDENTIFIER

IDENTIFICADOR DE PIEZAS

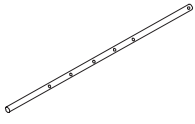
PART NUMBER NÚMERO DE PIEZA		1		FOR FIG. 1		FIG. NUMBER NÚMERO DE FIG.	
PART PIEZA				x1		QUANTITY CANTIDAD	
PART NAME		Side Apron - A		Delantal Lateral - A		NOMBRE DE PIEZA	
2	FOR FIG. 3	3	FOR FIG. 2	4	FOR FIG. 1	5	FOR FIG. 4
							
x1		x1		x2		x2	
Side Apron - B	Delantal Lateral - B	Soccer Playfield	Campo de Juego de Fútbol	End Apron	Delantal Final	Support Brace	Abrazadera de Soporte
6	FOR FIG. 5	7	FOR FIG. 5	8	FOR FIG. 5	9	FOR FIG. 5
							
x1		x1		x1		x1	
Leg - A	Pata - A	Leg - B	Pata - B	Leg - C	Pata - C	Leg - D	Pata - D
10	FOR FIG. 5	11	FOR FIG. 5	12	FOR FIG. 8	13	FOR FIG. 8
							
x2		x1		x4		x2	
Leg Panel - A	Panel de Pata - A	Leg Panel - B	Panel de Pata - B	3 - Hole Rod	Barra de 3 agujeros	2 - Hole Rod	Barra de 2 agujeros
14	FOR FIG. 9	15	FOR FIG. 9	16	FOR FIG. 7	17	FOR FIG. 7
							
x8		x8		x2		x2	
Rod End Cap	Capuchón de punta de barra	Handle	Manilla	Goal Box - Top	Caja de Gol - Superior	Goal Box - Bottom	Caja de Gol - Inferior
18	FOR FIG. 8	19	FOR FIG. 8	20	FOR FIG. 8	21	FOR FIG. 8
							
x13		x13		x16		x16	
Player - Blue	Player - Azul	Player - Red	Jugador - Rojo	Rod Washer	Arandela de barra	Rod Bumper	Amortiguador de barra
22	FOR FIG. 8						
							
x2							
5 - Hole Rod	Barra de 5 agujeros						









ACCESSORIES

ACCESORIOS

23		FOR FIG. 10	
		x2	
Soccer Ball	Pelota de fútbol		

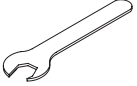

HARDWARE

HARDWARE

A1		FOR FIG. 6		A2		FOR FIG. 6		A3		FOR FIG. 1, 3, 4, 5		A4		FOR FIG. 6	
								x4		x12		x24		x4	
1/4"x1-7/8" Bolt	Perno 1/4"x1-7/8"			1/4" Washer	Arandela 1/4"			4x35mm Screw	Tornillo 4x35mm			1/4" Butterfly Bolt	Perno de mariposa 1/4"		
A5		FOR FIG. 7		A6		FOR FIG. 8		A7		FOR FIG. 8		A8		FOR FIG. 6	
								x8		x1		x26		x4	
4x12mm Screw	Tornillo 4x12mm			Allen Key	Llave Allen			3x18mm Screw	Tornillo 3x18mm			1/4" Nut	Tuerca 1/4"		
A9				x1		Wrench		Llave Inglesa		x1		Wrench		Llave Inglesa	

PRE-INSTALLED PARTS

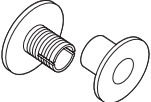
PIEZAS PREINSTALADAS

P1		FOR FIG. 5		P2		FOR FIG. 1, 3		P3		FOR FIG. 1, 3	
						x6		x16		x2	
1/4" T - Nut	T - Tuerca 1/4"			Plastic Rod Bushing	Cojinete de Barra Plástica			Plastic Ball Entry Rim	Aro de Entrada de Bola Plástica		

BEFORE ASSEMBLY

1. Find a clean, level place to begin the assembly of your product.
2. Verify that you have all listed parts as shown on the part list pages.

ANTES DE MONTAR

1. Encuentre un lugar limpio y nivelado para comenzar el ensamblaje del producto.
2. Compruebe que tenga todas las piezas que se muestran en la lista de piezas.

ASSEMBLY

MONTAJE

FIG. 1

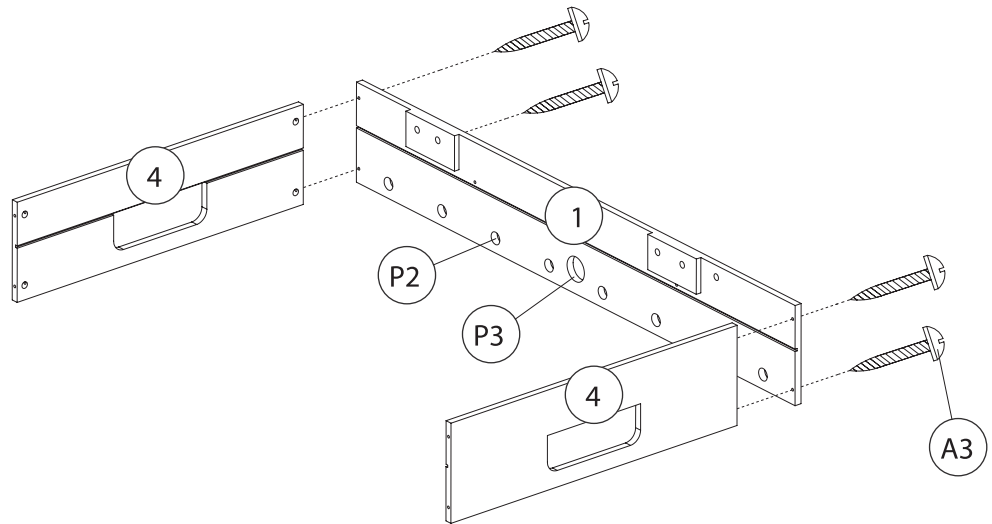
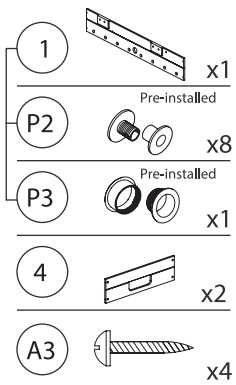
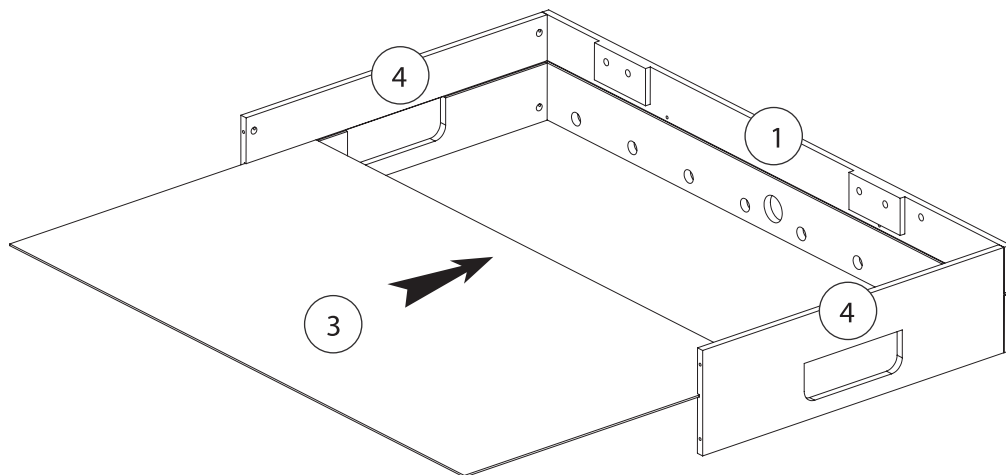
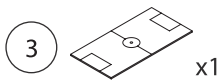

FIG. 2



ASSEMBLY

MONTAJE

FIG. 3

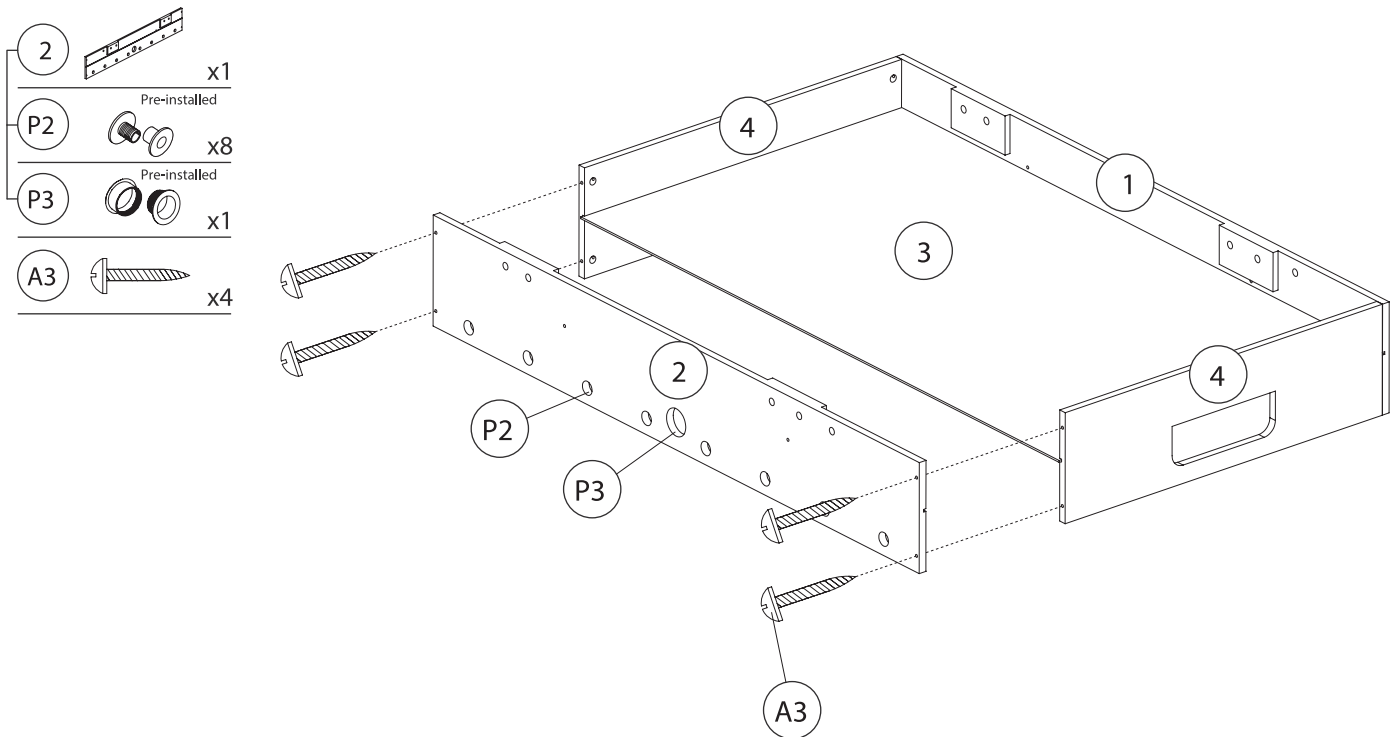
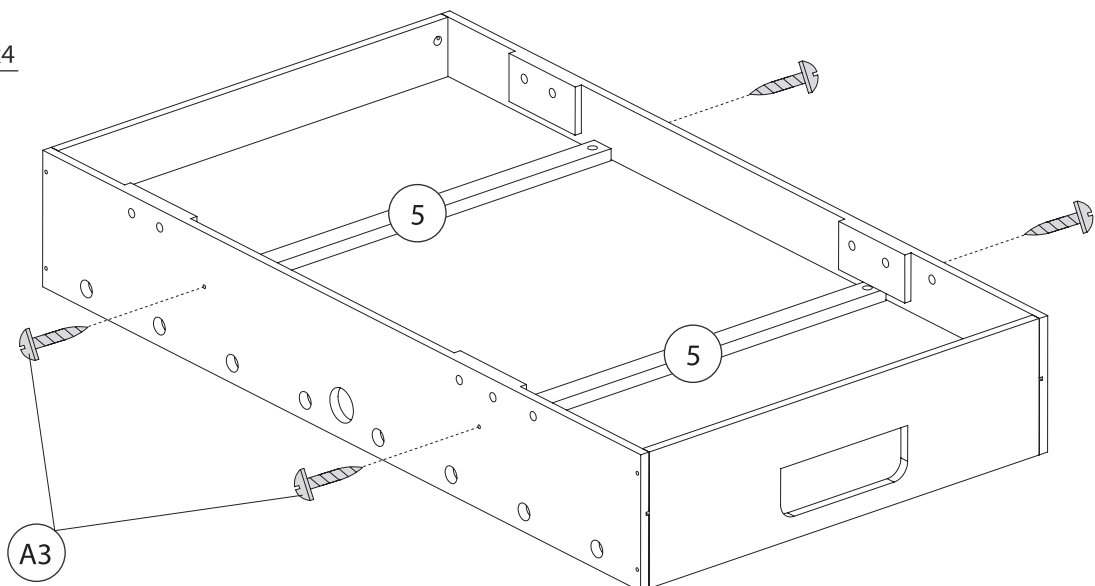
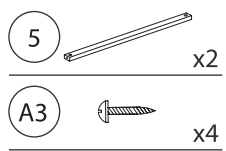

FIG. 4



ASSEMBLY

MONTAJE

FIG. 5

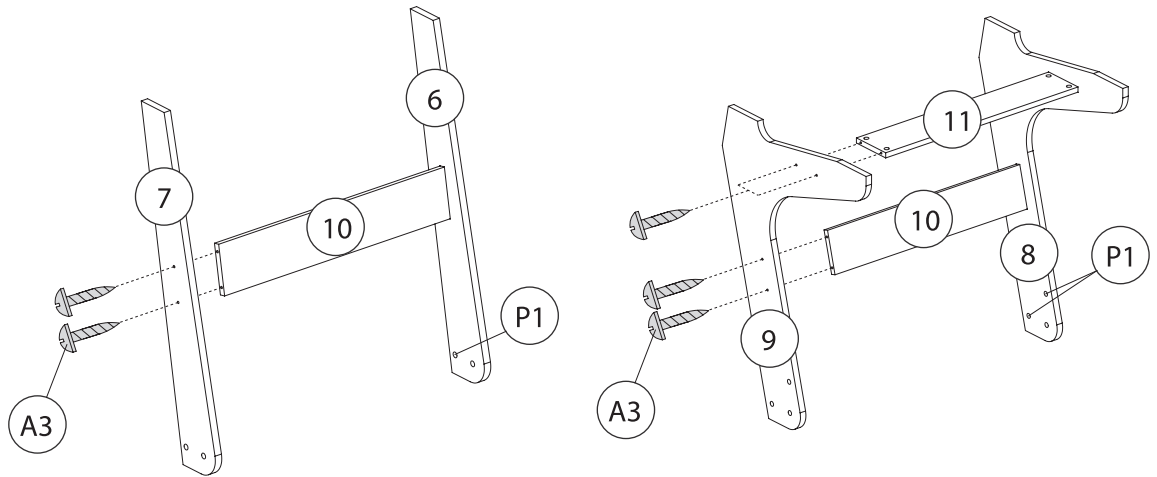
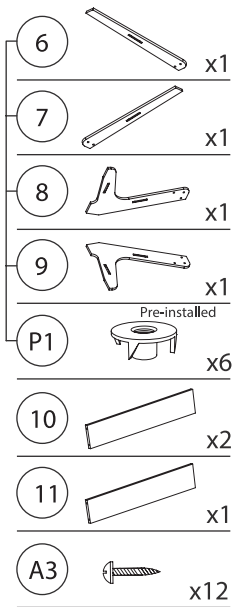
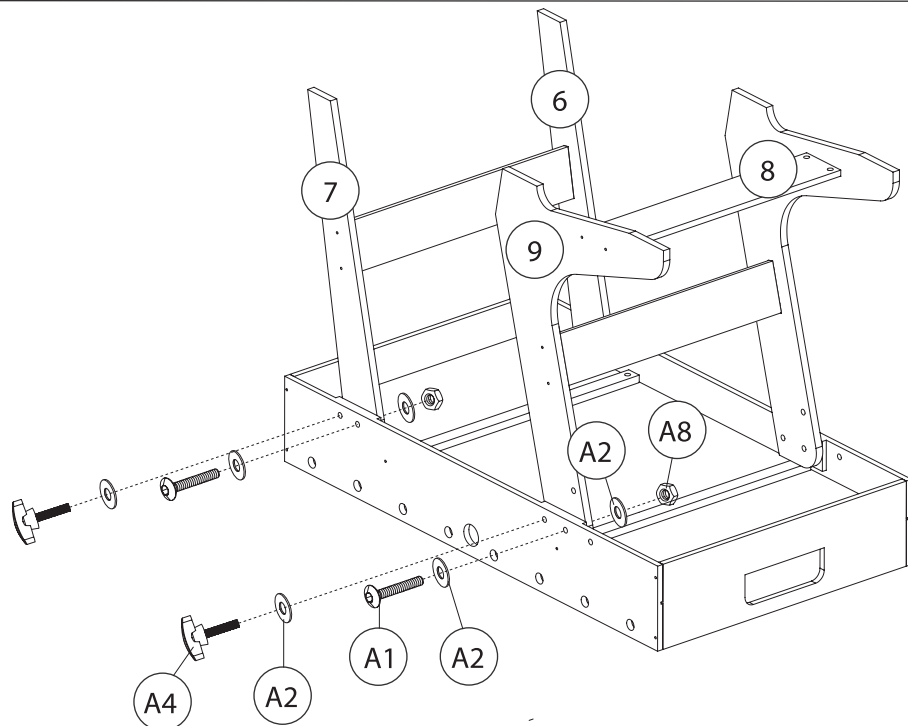
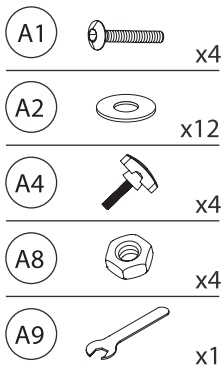
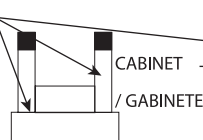

FIG. 6



HOLD BY THE TABLETOP

/SOSTENER DE LA SUPERFICIE DE LA MESA



CABINET

/GABINETE

DO NOT HOLD THE TABLE BY THE LEGS

/NO SOSTENER LA MESA POR LAS PATAS

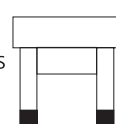

DO NOT LEAN THE TABLE ON ITS LEGS

/NO INCLINAR LA MESA SOBRE LAS PATAS

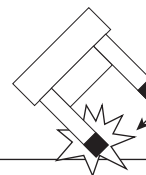

⚠ CAUTION

Two strong adults are recommended to turn over the table as shown.

1. Lift the table off the ground.
2. Turn the table over.
3. Place it on all four feet at the same time on the ground.

⚠ PRECAUCIÓN



Se recomienda la participación de dos adultos para invertir la mesa como se muestra.

1. Levante la tabla del suelo.
2. Voltee la mesa.
3. Coloque las cuatro patas en el suelo al mismo tiempo.

ASSEMBLY

MONTAJE

FIG. 7



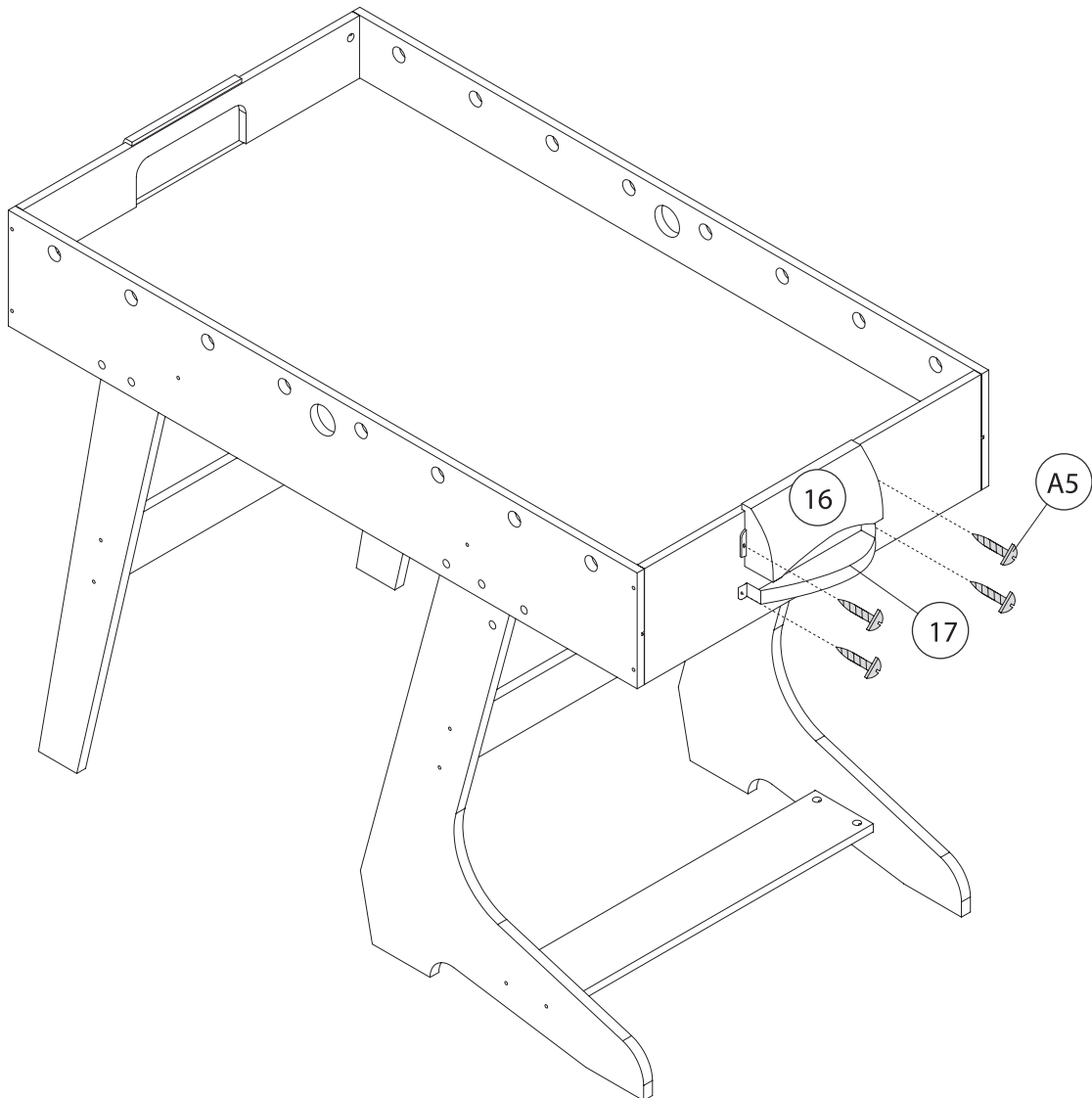





- 16  x2
- 17  x2
- A5  x8



ASSEMBLY

MONTAJE

FIG. 8

- 22  x2
- 12  x4
- 13  x2
- 18  x13
- 19  x13
- 20  x16
- 21  x16
- A7  x26

Note: The Rods have a hole at the end where their Handles will go.

Nota: Las Barras de Jugador hay un agujero en su parte final donde coloque las Manijas.

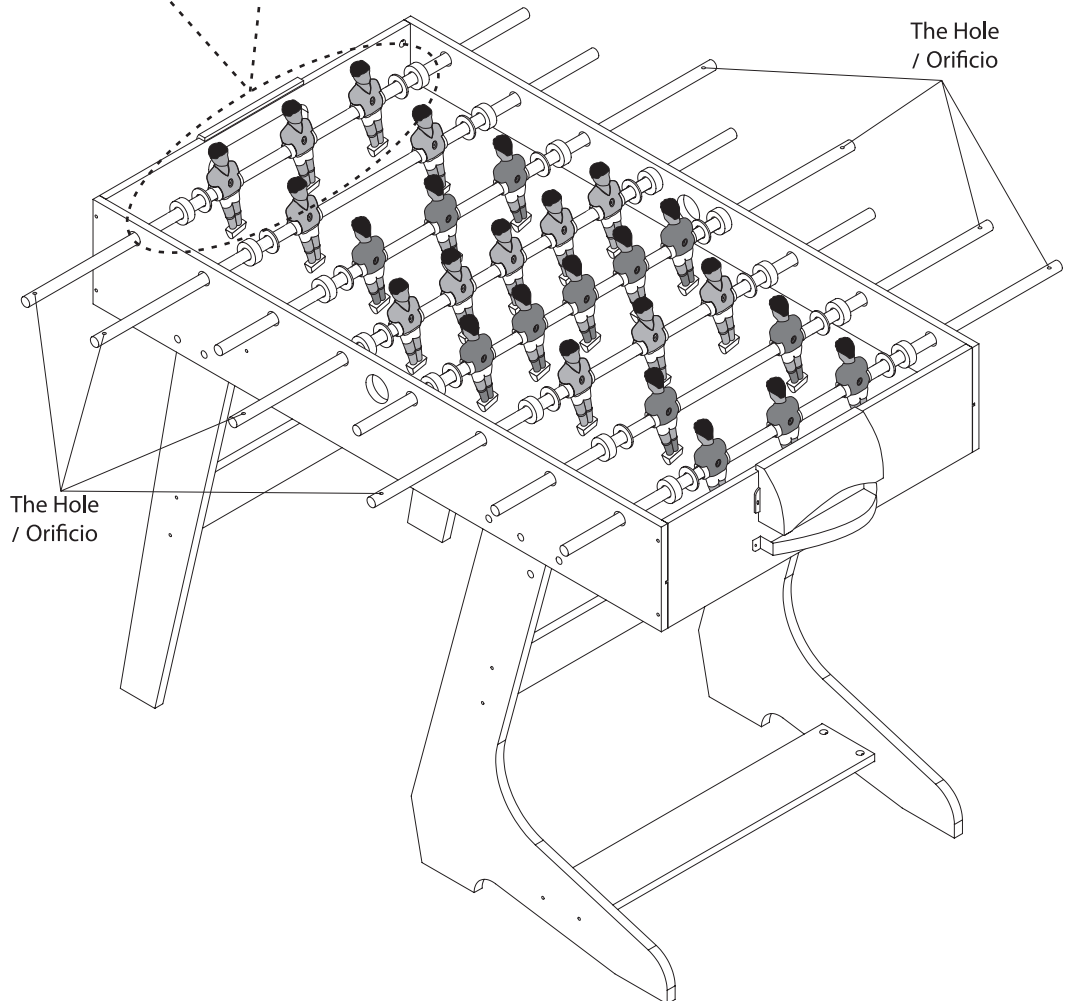
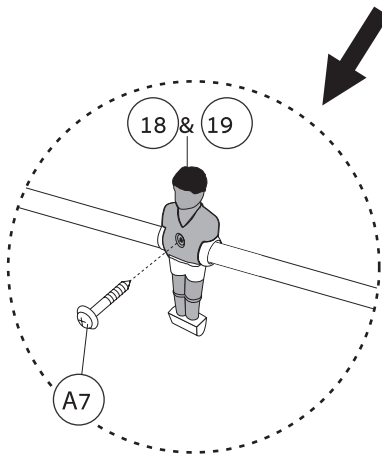
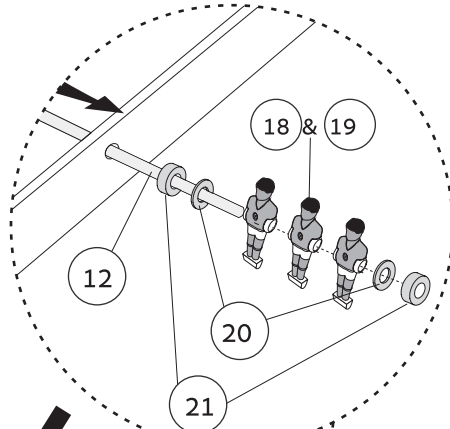
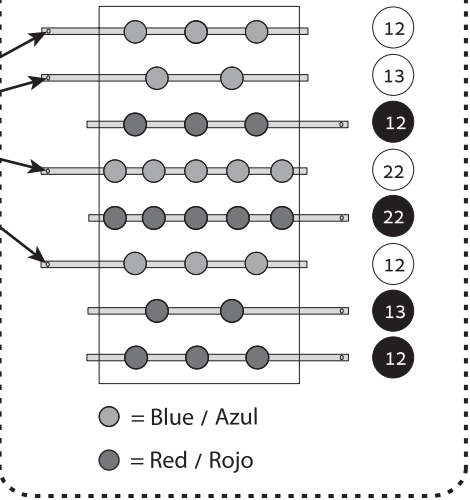

Order of players (Overhead View)
/ Orden de los jugadores (vista aérea)



ASSEMBLY

MONTAJE

FIG. 9

- 14  x8
- 15  x8

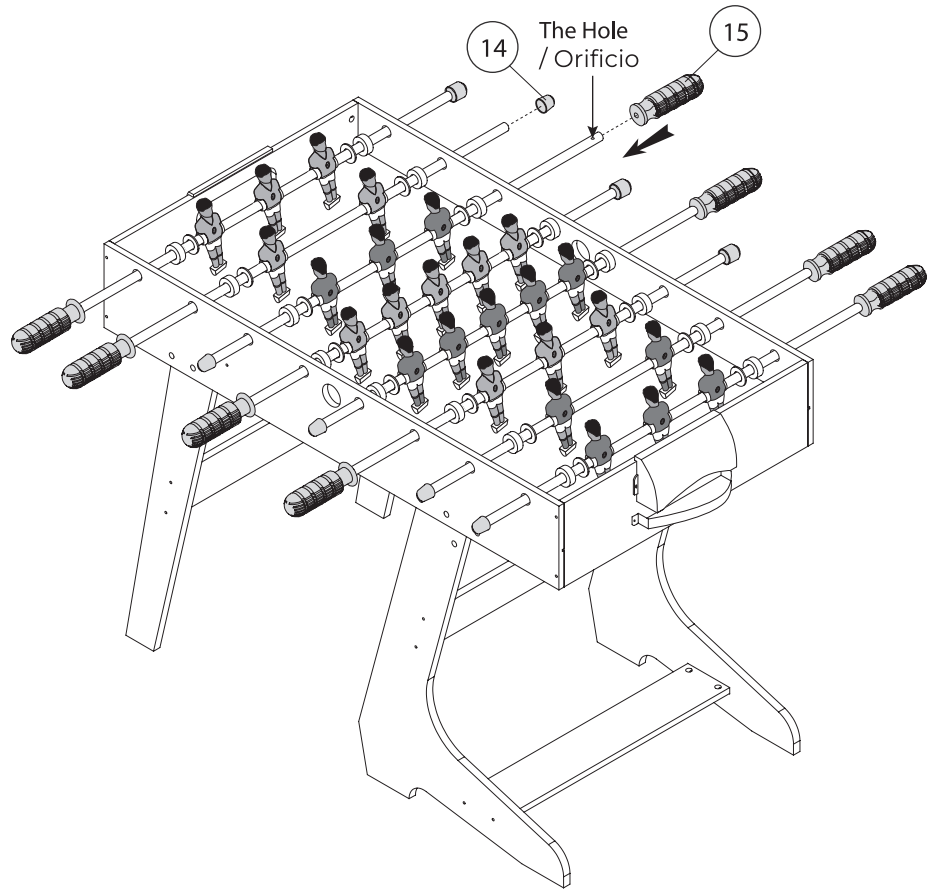

FIG. 10

- 23  x2

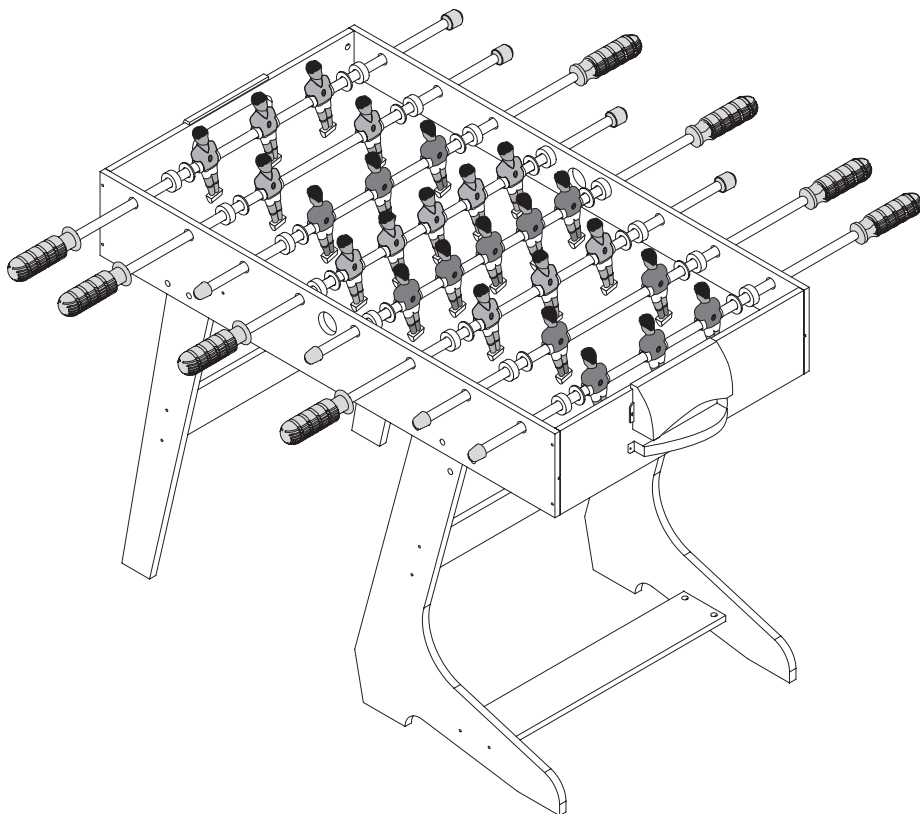
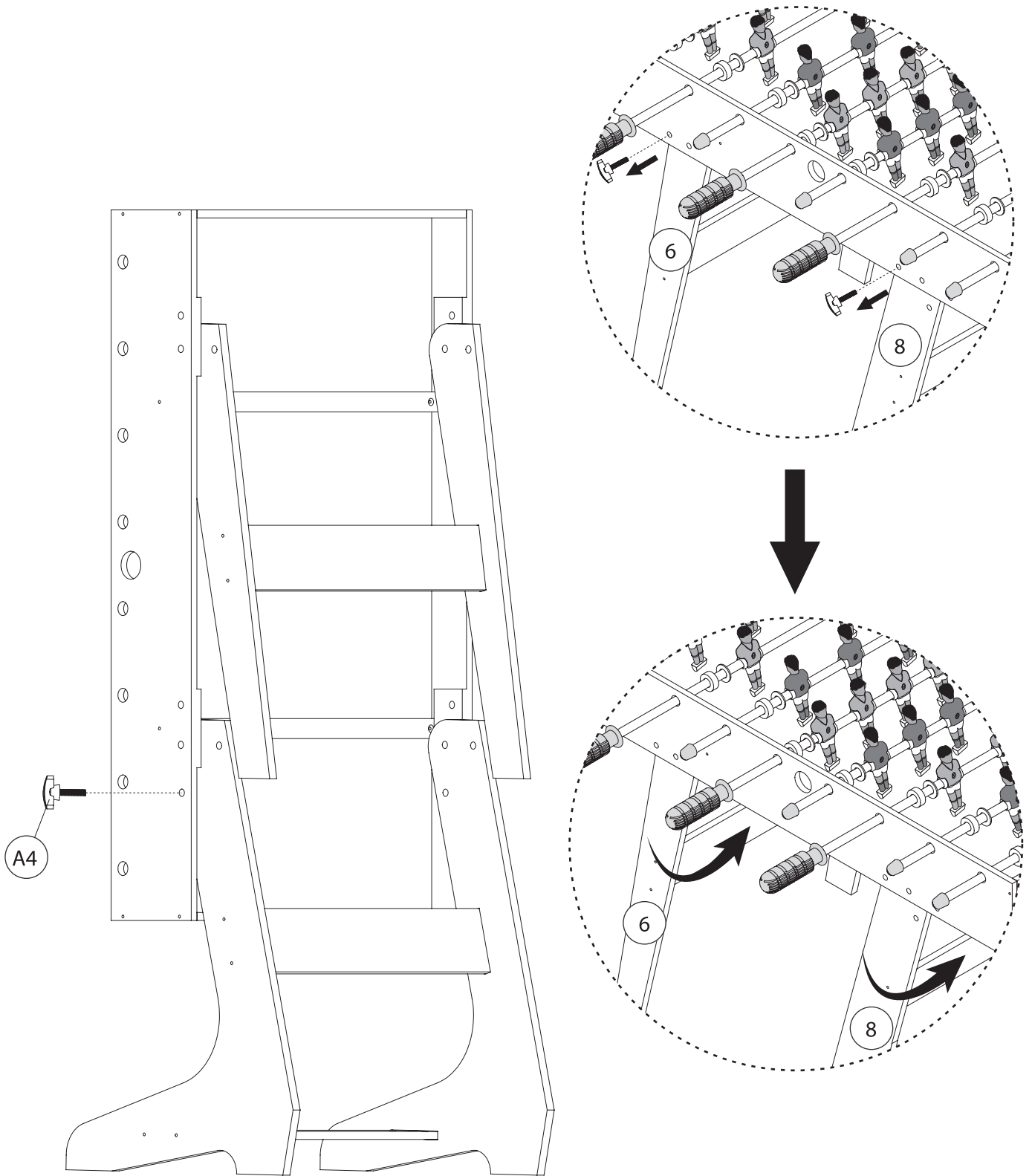

FIG. 11



אחריות מוגבלת

האחריות לשולחן תחול בתנאים הבאים

1. השימוש בשולחן הינו למטרת משחק ביתי ולא מסחרי.
2. תוקף האחריות הינו למשך 6 חודשים מהתאריך הנקוב בחשבונית הקנייה של השולחן.
3. האחריות מיועדת לטובת ביצוע תיקון אשר נדרש לפעולה תקינה של השולחן במהלך תקופת האחריות.
4. חברת 'פולטון בע"מ' מתחייבת להחליף בהקדם האפשרי כל חלק בשולחן הטעון החלפה במסגרת האחריות.
5. יש להציב את השולחן אך ורק בתוך הבית, ולא מחוצה לו!

האחריות לשולחן לא תחול במקרים הבאים

1. הקלקול/הנזק נגרמו בעקבות שימוש לא נכון בשולחן.
2. קלקול/נזק עקב כוח עליון (שריפה, הצפה, פגיעת ברק וכו').
3. השולחן תוקן, או בוצע בו ניסיון תיקון, או הוכנסו בו שינויים ע"י אדם שלא הוסמך לכך על-ידינו.
4. שבר מסיבה כלשהי.
5. חדירת נוזלים ו/או רטיבות מסוג כלשהו.
6. שימוש למטרות מסחריות בשולחן.
7. קלקול או נזק שאירעו כאשר השולחן הוצב מחוץ לבית.

לתשומת לבכם: האחריות תופעל אך ורק בתנאי שהשולחן יובא לתיקון בצירוף חשבונית הקנייה!

טל' שירות לקוחות 'פולטון בע"מ': 03-5614012

היבואן: פולטון בע"מ | ח.פ. 514832865 | דרך השלום 22, ת"א
טל': 03-5614012 | שנת ייצור: 2025 | ארץ ייצור: סין